

Australian Capital Territory

# **Dangerous Substances (National Occupational Health and Safety Commission Code of Practice for the Safe Removal of Asbestos 2<sup>nd</sup> Edition) Approval 2005**

## **Disallowable Instrument DI2005–297**

made under the

*Dangerous Substances Act 2004* – section 219 – Codes of practice

---

1. Pursuant to section 219 of the *Dangerous Substances Act 2004*, I approve the National Occupational Health and Safety Commission's Code of Practice for the Safe Removal of Asbestos 2<sup>nd</sup> Edition [NOHSC:2002(2005)] as attached.
2. This Instrument commences on 1 May 2006.

Katy Gallagher  
Minister for Industrial Relations

8 December 2005



**Australian Government**

---

**National Occupational  
Health and Safety Commission**

**CODE OF PRACTICE FOR THE SAFE REMOVAL OF  
ASBESTOS  
2<sup>ND</sup> Edition  
[NOHSC:2002(2005)]**

**CANBERRA  
APRIL 2005**

**NATIONAL OCCUPATIONAL HEALTH AND SAFETY COMMISSION**

**CODE OF PRACTICE FOR THE SAFE REMOVAL OF  
ASBESTOS  
2<sup>ND</sup> Edition  
[NOHSC:2002(2005)]**

**CANBERRA  
APRIL 2005**

© Commonwealth of Australia 2005

ISBN 1 920763 82 1

This work is copyright. You may download, display, print and reproduce this material, in unaltered form only, retaining this notice, for your personal use, non-commercial use or use within your organisation. Apart from any use permitted under the *Copyright Act 1968*, all rights are reserved. Requests for further authorisation should be directed to the Commonwealth Copyright Administration, Intellectual Property Branch, Department of Communications, Information Technology and the Arts, GPO Box 2154, Canberra ACT 2601 or by email to: [commonwealth.copyright@dcita.gov.au](mailto:commonwealth.copyright@dcita.gov.au)

## FOREWORD

The National Occupational Health and Safety Commission (NOHSC) leads and coordinates national efforts to prevent workplace deaths, injury and disease in Australia.

Through the quality and relevance of the information it provides, the NOHSC seeks to influence the awareness and activities of every person and organisation with a role in improving Australia's occupational health and safety (OHS) performance.

More specifically, the NOHSC aims to:

- support and enhance the efforts of the Australian, State and Territory governments to improve the prevention of workplace deaths, injury and disease;
- work in alliances with others to facilitate the development and implementation of better preventative approaches; and
- ensure the needs of small business are integrated into these approaches.

The NOHSC's *National OHS Strategy 2002-2012*, which was endorsed by the Workplace Relations Ministers' Council on 24 May 2002, records a commitment by all Australian, State and Territory governments, the Australian Chamber of Commerce and Industry and the Australian Council of Trade Unions to share in the responsibility of ensuring Australia's performance in work-related health and safety is continuously improved.

This *National OHS Strategy* sets out five 'national priorities' to achieve short-term and long-term improvements.

These priorities are to:

- reduce high incidence and high severity risks;
- improve the capacity of business operators and workers to manage OHS effectively;
- prevent occupational disease more effectively;
- eliminate hazards at the design stage; and
- strengthen the capacity of government to influence OHS outcomes.

In line with these priorities, the NOHSC declares **national codes of practice** under section 38 of the National Occupational Health and Safety Commission Act 1985 (Cth).

In common with other NOHSC documents, these national codes of practice are advisory instruments only, unless they are made mandatory by a law other than the National Occupational Health and Safety Commission Act or by an award or instrument made under such a law.

The application of a national code of practice in any particular State or Territory is the prerogative of that State or Territory.

The Australian Government and the NOHSC expect, however, that national codes of practice will be adopted by all Australian, State and Territory governments.

## CONTENTS

<b>FOREWORD</b>	<b>V</b>
<b>PREFACE</b>	<b>XI</b>
<b>PART 1. TITLE</b>	<b>1</b>
<b>PART 2. OBJECTIVE</b>	<b>2</b>
<b>PART 3. SCOPE AND APPLICATION</b>	<b>3</b>
<b>PART 4. DEFINITIONS</b>	<b>4</b>
<b>PART 5. INTRODUCTION</b>	<b>10</b>
<b>PART 6. HEALTH ASPECTS OF EXPOSURE TO AIRBORNE ASBESTOS FIBRES</b>	<b>11</b>
<b>PART 7. RESPONSIBILITIES</b>	<b>13</b>
<b>7.1 Consultation</b>	<b>13</b>
<b>7.2 Responsibilities of clients</b>	<b>13</b>
7.2.1 <i>Selection of an asbestos removalist</i>	13
7.2.2 <i>Register of ACM</i>	13
7.2.3 <i>Asbestos management plan</i>	14
7.2.4 <i>Asbestos removal requirements and specifications</i>	14
<b>7.3 Responsibilities of asbestos removalists</b>	<b>15</b>
7.3.1 <i>Licensing obligations and notification of OHS authorities</i>	15
7.3.2 <i>Asbestos removal control plan</i>	16
7.3.3 <i>Supervisory personnel</i>	16
7.3.4 <i>Competence</i>	16
7.3.5 <i>Training and information for asbestos removal workers</i>	17
7.3.6 <i>Health surveillance</i>	17
<b>PART 8. PLANNING FOR THE REMOVAL OF ACM</b>	<b>18</b>
<b>8.1 Asbestos removal control plan</b>	<b>18</b>
<b>8.2 Emergency plan</b>	<b>21</b>
<b>8.3 Planning for ACM removal from hot surfaces</b>	<b>21</b>

8.4	Planning for decontamination	21
<b>PART 9.</b>	<b>GENERAL REQUIREMENTS FOR THE REMOVAL OF ACM FROM WORKPLACES</b>	<b>23</b>
9.1	Determining the asbestos removal boundaries	23
9.2	Security, signs and barriers	23
9.3	Electrical and lighting installations	24
9.4	Preparation	25
9.5	Wet and dry methods for removing ACM	25
9.5.1	<i>Wet spray method (most preferred)</i>	25
9.5.2	<i>Dry removal method (least preferred)</i>	26
9.6	Asbestos removal equipment	27
9.6.1	<i>Tools</i>	27
9.6.2	<i>Spray equipment</i>	28
9.6.3	<i>Asbestos vacuum cleaners</i>	28
9.6.4	<i>Inspection of equipment</i>	29
9.7	Personal protective equipment (PPE)	29
9.7.1	<i>Respiratory protective equipment</i>	29
9.7.2	<i>Protective clothing and footwear</i>	30
9.8	Air monitoring	31
9.8.1	<i>'Control levels' for monitored airborne asbestos fibres</i>	33
9.9	Decontamination	33
9.9.1	<i>Workplace decontamination</i>	34
9.9.2	<i>Decontamination of equipment and tools</i>	34
9.9.3	<i>Decontamination of soil</i>	35
9.9.4	<i>Personal decontamination</i>	35
9.10	Waste removal	36
9.10.1	<i>Waste disposal program</i>	36
9.10.2	<i>Waste bags</i>	37
9.10.3	<i>Asbestos waste drums or bins</i>	38
9.10.4	<i>Asbestos waste skips etc</i>	39
9.11	Disposal of asbestos waste	39
9.12	Recycling of construction materials	40

<b>PART 10.</b>	<b>ADDITIONAL REQUIREMENTS FOR THE REMOVAL OF FRIABLE ACM</b>	<b>41</b>
10.1	Negative pressure exhaust units	41
10.2	Enclosures for large-scale asbestos removal work	42
10.2.1	<i>The enclosure</i>	42
10.2.2	<i>Testing the effectiveness of the enclosure</i>	44
10.2.3	<i>Decontamination unit</i>	44
10.2.4	<i>Remote decontamination units</i>	47
10.2.5	<i>Entering the asbestos work area</i>	47
10.2.6	<i>Decontamination procedures</i>	48
10.2.7	<i>Person outside the enclosure</i>	48
10.2.8	<i>Sealing the enclosure and decontamination unit upon the completion of the asbestos removal work</i>	48
10.3	Mini-enclosures for small-scale asbestos removal work	49
10.4	Glove bag removal method	50
10.5	'Wrap and cut' removal method	52
<b>PART 11.</b>	<b>CLEARANCE TO REOCCUPY AN ASBESTOS WORK AREA</b>	<b>54</b>
11.1	Visual inspections	54
11.2	Clearance monitoring	54
11.3	Settled dust sampling	55
<b>PART 12.</b>	<b>EXAMPLES OF SPECIFIC ASBESTOS REMOVAL PROCEDURES</b>	<b>56</b>
12.1	Removal of asbestos-cement products	56
12.1.1	<i>Preparation and enclosure</i>	56
12.1.2	<i>Removal</i>	57
12.1.3	<i>Decontamination</i>	58
12.2	Removal of vinyl floor tiles and sheet vinyl containing asbestos	58
12.2.1	<i>Preparation and enclosure</i>	59
12.2.2	<i>Removal</i>	59
12.3	Removal of asbestos-backed vinyl and millboard from beneath a vinyl floor	59
12.3.1	<i>Preparation and enclosure</i>	59



---

12.3.2	<i>Removal</i>	60
<b>12.4</b>	<b>Removal of asbestos gaskets and rope from plant and equipment</b>	<b>60</b>
12.4.1	<i>Preparation</i>	60
12.4.2	<i>Removal</i>	60
<b>12.5</b>	<b>Removal of asbestos switchboards or meter boards</b>	<b>61</b>
12.5.1	<i>Preparation</i>	61
12.5.2	<i>Removal</i>	61
12.5.3	<i>Decontamination</i>	61
<b>12.6</b>	<b>Removal of asbestos mastics and bitumen</b>	<b>62</b>
12.6.1	<i>Preparation</i>	62
12.6.2	<i>Removal</i>	62
<b>12.7</b>	<b>Removal and cleaning of ceiling tiles</b>	<b>62</b>
12.7.1	<i>Preparation</i>	62
12.7.2	<i>Method</i>	62
<b>12.8</b>	<b>Removal of asbestos friction products</b>	<b>63</b>
12.8.1	<i>Preparation and enclosure</i>	63
12.8.2	<i>Removal</i>	63
<b>APPENDIXES</b>		<b>65</b>
<b>APPENDIX A.</b>	<b>EXAMPLES OF ASBESTOS-CONTAINING MATERIALS</b>	<b>67</b>
<b>APPENDIX B.</b>	<b>EXAMPLES OF ASBESTOS WARNING LABELS AND SIGNS</b>	<b>71</b>
<b>APPENDIX C.</b>	<b>GUIDE TO THE SELECTION OF RESPIRATORY PROTECTION</b>	<b>73</b>
<b>APPENDIX D.</b>	<b>REFERENCES</b>	<b>77</b>
<b>APPENDIX E.</b>	<b>AUSTRALIAN STANDARDS</b>	<b>79</b>



## PREFACE

Asbestos poses a very significant hazard in Australia.

Exposure to asbestos fibres is known to cause mesothelioma, asbestosis and lung cancer.

Asbestos-containing materials were used extensively in Australian buildings and structures, plant and equipment and in ships, trains and motor vehicles during the 1950s, 1960s and 1970s, and some uses, including some friction materials and gaskets, were only discontinued on 31 December 2003.

**Appendix A** lists materials that have historically contained asbestos in Australia.

In 1993, the National Occupational Health and Safety Commission (NOHSC) released a package of regulations, standards and codes of practice, known as the National Hazardous Substances Regulatory Framework, as a blueprint for legislation to control hazardous substances in the workplace.

This framework, which among other things regulates asbestos in the workplace, has been adopted by all Australian, State and Territory jurisdictions, and therefore provides a consistent, national approach to the control of hazardous substances in Australian workplaces. Its requirements include control measures, labelling, Material Safety Data Sheets (MSDS), exposure standards, classifications and scheduling of hazardous substances and health surveillance.

In 2001 NOHSC declared a prohibition on all uses of chrysotile (white) asbestos from 31 December 2003, subject to a very limited range of exemptions, and confirmed earlier prohibitions of the use of amosite (brown) and crocidolite (blue) asbestos. (There are no known current uses in Australia of the other three forms of asbestos: actinolite, anthophyllite and tremolite.)

Under the *National Model Regulations for the Control of Workplace Hazardous Substances* this white asbestos ban prohibits the use (i.e. production, handling, storage, transport and disposal) of white asbestos except for:

- *bona fide* research or analysis;
- removal, handling and storage for disposal;
- white asbestos products which were *in situ* on 31 December 2003, which may remain *in situ* but may be replaced only by products which do not contain white asbestos;
- white asbestos encountered during non-asbestos mining; and
- a small number of time-limited exemptions for particular, specified uses for which substitution by an alternative to white asbestos is technically impossible or would create significantly *greater* health, safety and environmental risks.

In October 2003, NOHSC decided to review its asbestos guidance material and amend these documents to support the nation-wide prohibition on asbestos. This review has aimed to:

- ensure the technical accuracy of the documents;

- assist the introduction of ‘best practices’ in asbestos management, control and removal in Australian workplaces;
- provide a nationally consistent approach to control exposure to workplace asbestos, consistent with the prohibition and other health and safety regulations;
- limit exposure to chrysotile asbestos, mainly in situations where there is an exemption to the prohibition; and
- provide a safer working environment that reflects current knowledge.

One of the documents subjected to this review has been the *Code of Practice for the Safe Removal of Asbestos* [NOHSC:2002 (1988)]

This revised *Code of Practice for the Safe Removal of Asbestos* [NOHSC:2002 (2005)] provides guidance for industry to meet their legal obligations, and should be applied whenever *any* amount of asbestos or asbestos-containing material is to be removed from a workplace.

Asbestos removal should only be undertaken by a competent removalist. State and Territory legislation requires the licensing and registration of operators involved in asbestos removal, transport and disposal.

For more information on asbestos removal, please contact your State or Territory occupational health and safety (OHS) authorities.

The removal of asbestos-containing materials can potentially expose workers and others to higher levels of airborne asbestos fibres than leaving the materials *in situ*. The *National Code of Practice for the Management and Control of Asbestos in Workplaces* [NOHSC:2018(2005)] should be referred to for further information on when removal of ACM is required or recommended.

Accordingly, NOHSC has published a separate, but complementary, *National Code of Practice for the Management and Control of Asbestos in Workplaces* [NOHSC:2018 (2005)].

Both of these codes of practice should be consulted whenever asbestos or asbestos-containing materials are to be removed.

## **PART 1. TITLE**

This code of practice may be cited as the *Code of Practice for the Safe Removal of Asbestos* [NOHSC:2002(2005)].

## **PART 2. OBJECTIVE**

The purpose of this code of practice is to provide advice for the safe removal of asbestos and asbestos-containing materials (ACM) from buildings and structures, plant and equipment, and vehicles.

## **PART 3. SCOPE AND APPLICATION**

This code of practice covers the safe removal of all ACM from all workplaces. **Appendix A** lists the materials that have historically contained asbestos in Australia.

Removal is not always the best action. The decision to remove ACM should be made on the basis of a risk assessment. The *Code of Practice for the Management and Control of Asbestos in Workplaces* [NOHSC:2018 (2005)] provides guidance on when the removal of ACM is required or recommended.

## PART 4. DEFINITIONS

### **Air Monitoring**

means airborne asbestos fibre sampling to assist in assessing exposures and the effectiveness of control measures. Air monitoring includes exposure monitoring, control monitoring and clearance monitoring.

*Note: Air monitoring should be undertaken in accordance with the Guidance Note on the Membrane Filter Method for Estimating Airborne Asbestos Fibres [NOHSC:3003 (2005)]*

### **Airborne Asbestos Fibres**

means any fibres of asbestos small enough to be made airborne. For the purposes of monitoring airborne asbestos fibres, only respirable asbestos fibres (those fibres less than 3 µm wide, more than 5 µm long and with a length to width ratio of more than 3 to 1) are counted.

*Note: Airborne asbestos fibres are generated by the mechanical disintegration of Asbestos-Containing Materials (ACM) and subsequent dispersion of the fibres into the air from activities such as mining and the use, removal and disposal of asbestos and ACM. Airborne dust has the potential to contain respirable asbestos fibres.*

### **Air-line respirator**

Means a device through which air, at greater than atmospheric pressure, from a source of compressed air capable of providing breathing air, is supplied to the wearer by means of an air-line.

### **Asbestos**

means the fibrous form of mineral silicates belonging to the serpentine and amphibole groups of rock-forming minerals, including actinolite, amosite (brown asbestos), anthophyllite, chrysotile (white asbestos), crocidolite (blue asbestos), tremolite, or any mixture containing one or more of the mineral silicates belonging to the serpentine and amphibole groups.

### **Asbestos-Cement (AC)**

means products consisting of sand aggregate and cement reinforced with asbestos fibres (e.g. asbestos cement pipes and flat or corrugated asbestos cement sheets).

### **Asbestos-Containing Material (ACM)**

means any material, object, product or debris that contains asbestos.

*Note: Information for determining if a material contains asbestos is provided in Part 9 of the National Code of Practice for the Management and Control of Asbestos in Workplaces [NOHSC: 2018(2005)].*



<b>Asbestos Removalist</b>	means a competent person who performs asbestos removal work.  <i>Note: An asbestos removal licence is required in all State and Territory jurisdictions for the removal of friable ACM. Some States and Territories also require a licence for removal of specified quantities of ACM, regardless of whether they are friable, and relevant OHS authorities should be consulted prior to any removal work.</i>
<b>Asbestos Removal Control Plan</b>	means a document which identifies the control measures which will be implemented to ensure workers and other persons are not at risk when asbestos removal work is being conducted.
<b>Asbestos Removal Site</b>	means the Asbestos Work Area and the region surrounding and adjacent to the Asbestos Work Area that may be affected by Asbestos Removal Work. It includes any area where there is a potential for exposure to asbestos.
<b>Asbestos Removal Work</b>	means the removal of ACM.
<b>Asbestos Vacuum Cleaner</b>	means a vacuum cleaner that is fitted with a High Efficiency Particulate Air (HEPA) Filter and complies with Australian Standard 3544-1988 <i>Industrial Vacuum Cleaners for Particulates Hazardous to Health</i> . A domestic vacuum cleaner is not suitable for use with asbestos.
<b>Asbestos Waste</b>	means all removed ACM and disposable items used during the asbestos removal work, such as plastic sheeting used for an enclosure or to cover surfaces in the asbestos work area, disposable coveralls, disposable respirators and rags used for cleaning.
<b>Asbestos Work Area</b>	means the immediate area in which work on ACM is taking place. The boundaries of the Asbestos Work Area must be determined by a risk assessment.  <i>Note: The asbestos work area should include the boundaries of an enclosure or barriers set up to warn or restrict access to the area where the asbestos work is being undertaken.</i>
<b>Breathing Zone</b>	means a hemisphere extending in front of a person's face, with a radius of 300 mm from the midpoint of an imaginary line between the ears.
<b>Clearance Inspection</b>	means an inspection, carried out by a competent person, to verify that an asbestos work area is safe to be returned to normal use after work involving the disturbance of ACM has taken place. A clearance inspection must include a visual inspection, and

may also include clearance monitoring and/or settled dust sampling.

*Note: A clearance inspection should only be carried out when the asbestos work area is dry.*

### **Clearance Monitoring**

means air monitoring using static or positional samples to measure the level of airborne asbestos fibres in an area following work on ACM. An area is 'cleared' when the level of airborne asbestos fibres is measured as being below 0.01 fibres/mL.

*Note: Static or positional samples are taken at fixed locations which are usually between one and two metres above floor level,*

### **Client**

means any person with control who commissions Asbestos Removal Work.

*Note: In some circumstances the Client may be the Asbestos Removalist or may work for the same employer as the Asbestos Removalist.*

### **Competent Person**

means a person possessing adequate qualifications, such as suitable training and sufficient knowledge, experience and skill, for the safe performance of the specific work.

*Note: A licence may be required for some of the tasks described in this document as requiring a competent person.*

### **Control Level**

means the airborne concentration of a particular substance which, if exceeded, indicates a need to implement a control, action or other requirement. Control levels are generally set at no more than half the NES for the substance. Control levels are occupational hygiene 'best practice', and are *not* health-based standards.

*Note: The first Control Level for Asbestos is set at 0.01 fibres/mL of air.*

### **Control Monitoring**

means air monitoring, using static or positional to measure the level of airborne asbestos fibres in an area during work on ACM. Control monitoring is designed to assist in assessing the effectiveness of control measures. Its results are not representative of actual occupational exposures, and should not be used for that purpose.

*Note: Static or positional samples are taken at fixed locations which are usually between one and two metres above floor level,*

<b>Dust and Debris</b>	means visible particles, fragments or chunks of material, large and heavy enough to have settled in the work area, that are likely to have originated from ACM.
<b>Exposure Monitoring</b>	<p>means air monitoring to determine a person's likely exposure to a hazardous substance. Exposure monitoring is designed to reliably estimate the person's exposure, so that it may be compared with the NES.</p> <p><i>Note: Exposure monitoring includes airborne asbestos fibre sampling, analysis, estimation of time-weighted average exposure and interpretation. Samples are taken within the breathing zone and are usually obtained by fastening the filter holder to the worker's jacket lapel.</i></p>
<b>Friable (Asbestos)</b>	<p>means asbestos-containing material which, when dry, is or may become crumbled, pulverised or reduced to powder by hand pressure.</p> <p><i>Note: This may include ACM that have been subjected to conditions that leave them in a state where they meet the above definition, such as weathering, physical damage, water damage etc.</i></p>
<b>Hazard</b>	means any matter, thing, process or practice that may cause death, injury, illness or disease.
<b>Health Surveillance</b>	means the monitoring of a person to identify any changes in their health as a result of exposure to a hazardous substance. It does not include Exposure Monitoring.
<b>High Efficiency Particulate Air (HEPA) Filter</b>	means a disposable, extended media, dry type filter, in a rigid frame, with a minimum filtration efficiency of 99.97% for nominal 0.3 µm diameter thermally generated dioctylphthalata (DOP) particles or an equivalent efficiency for a specified alternative aerosol and with an initial maximum resistance to airflow of 250 pa when tested at its rated airflow capacity (see Australian Standard 4260-1997 <i>High Efficiency Particulate (HEPA) Filters – Classification, Construction and Performance</i> ).
<b>In situ</b>	means fixed or installed in its original position, not having been moved.
<b>Inaccessible Areas</b>	means areas which are difficult to access, such as wall cavities and the interiors of plant and equipment.

**Membrane Filter Method (MFM)** means the technique outlined in the NOHSC *Guidance Note on the Membrane Filter Method for Estimating Airborne Asbestos Fibres* [NOHSC:3003 (2005)]

**National Exposure Standard (NES)** means an airborne concentration of a particular substance, within the worker's breathing zone, which according to current knowledge, should not cause adverse health effects or undue discomfort to nearly all workers. NES are established, from time to time, by the National Occupational Health and Safety Commission (NOHSC) and are published on the NOHSC website (see **Appendix D**).

*Note: The NES for all forms of asbestos is 0.1 fibres/mL of air, measured using the Membrane Filter Method (MFM).*

**Person with Control** means, in relation to premises, a person who has control of premises used as a workplace. The person with control may be:

- (a) the owner of the premises;
- (b) a person who has, under any contract or lease, an obligation to maintain or repair the premises;
- (c) a person who is occupying the premises;
- (d) a person who is able to make decisions about work undertaken at the premises; or
- (e) an employer at the premises.

**Personal Protective Equipment (PPE)** means equipment and clothing that is used or worn by an individual person to protect themselves against, or minimise their exposure to, workplace risks. It includes items such as facemasks and respirators, coveralls, goggles, helmets, gloves and footwear (see Section 9.7).

**Respirable Asbestos Fibre** means a fibre of Asbestos small enough to penetrate into the gas exchange regions of the lungs. Respirable asbestos fibres are technically defined as fibres that are less than 3 µm wide, more than 5 µm in length and have a length to width ratio of more than 3 to 1.

**Risk** means the likelihood of a hazard causing harm to a person.

*Note: In this code of practice, Risk relates to illness or disease arising from exposure to Airborne Asbestos Fibres.*

**Settled Dust Sampling**

means the sampling and analysis of settled surface dust to provide an indication of cleanliness following disturbance of ACM. Settled dust sampling does *not* provide an indication of risk to health. Sampling techniques include the use of adhesive tape, wipe or micro-vacuum (using an air sampling pump and filter). Analysis can be by polarised light microscopy (PLM) or transmission electron microscopy (TEM).

*Note: Contamination may occur as a result of deterioration of, or work processes involving ACM.*

**Shadow Vacuuming**

means the operation of an asbestos vacuum cleaner that is either directly attached to a tool or hand-held by a second worker as close as possible to the source of released Asbestos fibres throughout the use of the tool.

**Structure**

means any construction, whether temporary or permanent.

*Note: A structure includes a bridge, erection, edifice, wall, chimney, fence, earth works, reclamation, ship, floating structure or tunnel.*

**Work**

means any activity, physical or mental, carried out in the course of a business, industry, commerce, an occupation or a profession.

**Worker**

means a person who does work, whether or not for reward or recognition.

*Note: 'Workers' include persons working under contracts of employment, apprenticeships, traineeships and other contracts of service, but they also include other persons subject to direction by persons with control, such as volunteers and work experience students.*

**Workplace**

means any place where a person works.

## PART 5. INTRODUCTION

As indicated in the Preface to this code of practice, asbestos-containing materials (ACM) were used extensively in Australian buildings and structures, plant and equipment and in ships, trains and motor vehicles during the 1950s, 1960s and 1970s, and some uses, including some friction materials and gaskets, were only discontinued on 31 December 2003.

For example, ACM were often used for insulation (lagging) and gaskets on plant and equipment such as boilers, furnaces, calorifiers, pipework, the engine rooms of vessels, exhausts and heaters. Refineries and processing plants also often had gaskets made of ACM. In many of these applications the ACM were, and are, friable and easily disturbed unless they have outer protective coverings.

ACM have also been used extensively in friction products, including the brake pads and clutch plates not only of vehicles but also of plant and equipment such as lift motors and hoists. Unless evidence proves otherwise, it should always be assumed that all brake and clutch linings contain asbestos.

**Appendix A** lists materials that have historically contained asbestos in Australia.

This code of practice sets out control measures for the safe removal of ACM.

The removal of ACM can be a high risk process, because there is often significant disturbance of the ACM and thus a potential for exposure to respirable airborne asbestos fibres.

A high degree of control is therefore essential for the safe removal of ACM. People within the asbestos work area need to have protection, most especially respiratory protection, that is fully adequate to control the exposure risk. It is also important to ensure no asbestos-contamination occurs outside the asbestos work area.

The work practices and precautions that need to be adopted for the removal of ACM vary considerably, depending on the type of ACM involved, their condition and their location. The controls discussed in this code of practice therefore need to be adapted to the particular circumstances of each asbestos removal process.

Similarly, if an ACM to be removed is not specifically covered by this code, you should use and adapt the control measures in this code that are most likely to control the risks of asbestos exposure in the particular circumstances.

When in doubt, your State or Territory occupational health and safety (OHS) authority should be consulted on the control measures required.

## PART 6. HEALTH ASPECTS OF EXPOSURE TO AIRBORNE ASBESTOS FIBRES

Asbestos is a known carcinogen. The inhalation of asbestos fibres is known to cause mesothelioma, lung cancer and asbestosis.

**Malignant mesothelioma** is a cancer of the outer covering of the lung (the pleura) or the abdominal cavity (the peritoneum). It is usually fatal.

Mesothelioma is caused by the inhalation of needle-like asbestos fibres deep into the lungs where they can damage mesothelial cells, potentially resulting in cancer

The latency period is generally between 35 and 40 years, but it may be longer, and the disease is very difficult to detect prior to the onset of illness.

Mesothelioma was once rare, but its incidence is increasing throughout the industrial world as a result of past exposures to asbestos. Australia has the highest incidence rate in the world.

**Lung cancer** has been shown to be caused by all types of asbestos. The average latency period of the disease, from the first exposure to asbestos, ranges from 20 to 30 years. Lung cancer symptoms are rarely felt until the disease has developed to an advanced stage.

**Asbestosis** is a form of lung disease (pneumoconiosis) directly caused by inhaling asbestos fibres, causing a scarring (fibrosis) of the lung tissue which decreases the ability of the lungs to transfer oxygen to the blood. The latency period of asbestosis is generally between 15 and 25 years.

Asbestos poses a risk to health whenever asbestos fibres become airborne and people are exposed to these fibres.

Accordingly, exposure should be prevented. The national exposure standard (NES) of 0.1 fibres/mL should *never* be exceeded, and control measures should be reassessed whenever air monitoring indicates the 'control level' of 0.01 fibres/mL has been reached (see section 9.8.1 of this code, and also see the *Code of Practice for the Management and Control of Asbestos in Workplaces* [NOHSC: 2018 (2005)]).

ACM can release asbestos fibres into the air whenever they are disturbed, and especially during the following activities:

- any direct action on ACM, such as drilling, boring, cutting, filing, brushing, grinding, sanding, breaking, smashing or blowing with compressed air (State and Territory legislation prohibits most of these actions, and the relevant laws should be checked before performing *any* activity on ACM);
- the inspection or removal of ACM from workplaces (including vehicles, plant and equipment);
- the removal of materials from vehicles, plant, equipment or workplaces; and
- the renovation or demolition of buildings containing ACM.

Non-friable ACM that has been subjected to extensive weathering or deterioration also has a higher potential to release asbestos fibres into the air.

**Health surveillance** is an important part of the monitoring of exposure to hazardous substances, including asbestos, to ensure the health and safety of people in workplaces.

Information on health surveillance requirements for asbestos removalists is provided in section 7.3.6 of this code of practice.



## **PART 7. RESPONSIBILITIES**

### **7.1 Consultation**

Australian, State, Territory occupational health and safety legislation requires persons in control to consult with health and safety representatives and other workers at the workplace on occupational health and safety issues. This legislation sets out requirements for establishing these consultative processes.

As with all occupational health and safety issues, if ACM are to be removed from a workplace, there must be full consultation, information-sharing and involvement by everyone in the workplace, including employers, workers and contractors, at each step of the ACM removal process, using the established consultative mechanisms.

Persons in adjoining properties that might be affected by the asbestos removal activities must also be consulted.

### **7.2 Responsibilities of clients**

#### **7.2.1 Selection of an asbestos removalist**

The client is responsible for ensuring an asbestos removalist carries out the removal of ACM.

The client should nominate one or more persons to liaise with the asbestos removalist.

If an asbestos removalist license is required and the asbestos removalist does not initially provide its licence details, the client should request this information.

The relevant State or Territory occupational health and safety (OHS) authority should be consulted to determine licensing requirements before any removal of the ACM.

#### **7.2.2 Register of ACM**

The client should give the asbestos removalist a copy of the workplace's register of ACM, developed in accordance with the *Code of Practice for the Management and Control of Asbestos in Workplaces* [NOHSC: 2018 (2005)], before any removal work commences.

It is the client's responsibility to identify ACM. This responsibility may not be abdicated to the asbestos removalist.

If there is no register of ACM, it is the client's responsibility to ensure a register is established before removal commences.

If no register is provided, it should be *presumed* by the client and the asbestos removalist that asbestos is present in all materials, as described in section 9.2 of the *Code of Practice for the Management and Control of Asbestos in Workplaces* [NOHSC: 2018 (2005)].

### **7.2.3 Asbestos management plan**

The decision to remove ACM should be based on the application of an asbestos management plan, which will have been developed in accordance with the *Code of Practice for the Management and Control of Asbestos in Workplaces* [NOHSC: 2018 (2005)]

Among other things, the client must ensure that a risk assessment is performed by a competent person prior to the asbestos removal and that the asbestos removalist takes this risk assessment into account in developing the asbestos removal control plan.

In some cases, especially when thermal and acoustic insulation is being removed, the full extent of the ACM is not always known until the removal is underway. In these circumstances the client should identify the ACM as far as possible before asbestos removal commences, and if additional ACM are found a further risk assessment should be performed by a competent person.

### **7.2.4 Asbestos removal requirements and specifications**

The client should supply precise details of its asbestos removal requirements to the asbestos removalist, and also to the relevant State or Territory OHS authority if this is required under State or Territory legislation, prior to the commencement of any asbestos removal work.

Work specifications for the removal of ACM should address the following issues:

#### **What:**

- Technical descriptions of the ACM to be removed, with details on the type and condition of ACM present, their quantity and any special or unusual materials, including any residual dust and debris.
- Details on any section or materials to be left in place.
- Cleaning/decontamination: the areas to be protected from airborne dust and the areas to be cleaned or decontaminated upon completion.
- The dimensions of surfaces and fittings. (The provision of adequately detailed drawings should be sufficient.)
- The types of fittings and supports, and whether or not these should be removed or disposed of with the waste.
- The storage and disposal of asbestos waste.
- The type of finish required.
- Arrangements for clearance inspections and air monitoring.

#### **Where:**

- Location of the removal:
  - Indoors

- Outdoors but protected
  - Outdoors and exposed to weather
  - Enclosed in ducts (e.g. air-conditioning heater boxes) or trenches below ground level
  - Difficult or unusual site conditions and access (such as working at heights), which will influence the selection or application of removal methods, particularly concerning transport, scaffolding and weather protection.
- Areas that are difficult to access, such as wall and ceiling cavities. These could have hidden ACM, which would need to be further assessed for their risks.
  - Details on any areas that have not been assessed but could contain asbestos.
  - Safe work procedures for dealing with any unknown or unexpected asbestos found during removal work.

**Hazards:**

- Confirmation and details of residual heat in pipework, boilers, turbines or refinery equipment. Attention should be paid to the possibility of burns to workers.
- Other temperature considerations:
  - Normal working temperature for each portion of the plant
  - Ambient temperature in the asbestos work area.
- The location of electrical cables, switches and panels, which may pose an electrical hazard and need to be isolated or protected to prevent the electrocution of asbestos removal workers.
- Any unusual or specific hazards associated with the removal work, such as brittle roofs or working at heights.
- Site occupancy restrictions and conditions, including access and egress, work schedules and emergency management arrangements, including emergency communication and evacuation plans.

## **7.3 Responsibilities of asbestos removalists**

### ***7.3.1 Licensing obligations and notification of OHS authorities***

In all States and Territories an asbestos removalist must hold a licence before being permitted to remove friable ACM.

Notification of the State or Territory OHS authority about each removal task may also be required.

Some States and Territories require a licence and notification for the removal of specified quantities of ACM even if they are non-friable.

The relevant State or Territory OHS authority should be consulted prior to any ACM removal, to determine their requirements.

Asbestos removalists must provide their licence details to their clients.

### ***7.3.2 Asbestos removal control plan***

As described in section 8.1 of **Part 8** of this code of practice, the asbestos removalist must develop an asbestos removal control plan, specific to the site, before commencing any asbestos removal work.

The asbestos removal control plan should be based on the removal requirements and specifications supplied by the client (see section 7.2.4).

If the client does not initially provide these requirements and specifications, the asbestos removalist should request this information, which must be provided prior to finalisation of the asbestos removal control plan.

The asbestos removalist should consult with the client to finalise the asbestos removal control plan, and the client should be provided with a final copy of this plan.

The presence or likelihood of other hazards associated with the asbestos removal work should be assessed by the asbestos removalist (e.g. work at heights, work in confined spaces, electrical safety and heat stress).

The relevant State or Territory OHS authority should be consulted, if necessary, to determine whether the asbestos removal control plan has to be submitted to this authority.

### ***7.3.3 Supervisory personnel***

The asbestos removalist must ensure the removal is adequately supervised and is carried out in a safe manner.

The asbestos removalist should ensure all supervisory personnel have a detailed knowledge of the precautions and procedures outlined in this code of practice.

The supervisory personnel should ensure that the client is reliably and regularly informed of the progress of the removal work.

### ***7.3.4 Competence***

All persons involved in the removal of ACM must be competent for the tasks allocated to them.

Some States and Territories regulate the competencies of asbestos removalists through licensing schemes (see section 7.3.1).

### **7.3.5 Training and information for asbestos removal workers**

Persons carrying out asbestos removal work should be trained so they can carry out this work safely and without risk to their own health or the health of others.

This training must reflect the specific type of asbestos work to be undertaken.

The relevant State or Territory OHS authority should be consulted for advice on training courses for persons carrying out asbestos removal work.

Asbestos removalists should keep a written record of all training provided to each of their asbestos removal workers and ensure these records are readily accessible.

Asbestos removalists should also provide the following information to all of their asbestos removal workers and to all applicants for employment as an asbestos removal worker:

- the health risks associated with exposure to asbestos;
- the need for, and details of, health surveillance, including medical examinations in accordance with the *Guidelines for Health Surveillance* [NOHSC:7039 (1995)]; and
- details of legislation relating to the control and safe removal of asbestos.

### **7.3.6 Health surveillance**

Health surveillance is an important part of the monitoring of exposure to hazardous substances, including asbestos, to ensure the health and safety of people in workplaces.

One of its main purposes is to ensure that control measures are effective and provide an opportunity to reinforce specific preventive measures and safe work practices.

The asbestos removalist must establish a health surveillance program, as determined by an assessment of the potential for exposure to asbestos, in accordance with the requirements of the NOHSC *Model Regulations for the Control of Workplace Hazardous Substances* [NOHSC:1005 (1994)] and consultations with relevant State or Territory OHS authorities to identify any specific health surveillance requirements.

Additional guidance on health surveillance may be obtained from the NOHSC *Guidelines for Health Surveillance* [NOHSC: 7039 (1995)], which set out, in a very practical manner, the minimum requirements for health surveillance for persons engaged in work that may expose them to asbestos or other hazardous substances.

## PART 8. PLANNING FOR THE REMOVAL OF ACM

Planning requirements for the removal of ACM can differ greatly, depending on the specific asbestos removal task, the type, location, quantity and condition of the ACM to be removed, whether there are workers or other persons nearby and many other factors.

Asbestos removal work includes:

- the removal of ACM from buildings and structures, including demolition/excavation sites;
- the removal of ACM from plant and equipment, including friction products; and
- cleaning up asbestos dust or debris.

Whatever the circumstances, it is essential for an asbestos removal control plan to be developed and implemented whenever any ACM is to be removed.

Any misunderstanding could lead to the use of unsafe removal methods, potentially endangering the health of asbestos removal workers, persons in adjoining properties and local residents.

**Appendix A** presents a list of ACM which are commonly found in Australian workplaces.

### 8.1 Asbestos removal control plan

The asbestos removalist should develop a site-specific control plan before commencing any asbestos removal work.

The purpose of each asbestos removal control plan is to help ensure the removal is well planned and carried out in a safe manner.

The asbestos removal control plan should include specifications and/or drawings addressing *at least* all of the items in **Table 1** which are relevant to the particular removal job.

Additional information should be included for each individual removal job as necessary.

The asbestos removal control plan should be finalised in consultation with the client.

In *Table 1*,

- ✓ means that the asbestos removal control plan should include this information
- means that this information may not be necessary for some asbestos removal tasks. Any decision not to include the information in the asbestos removal control plan must be made on a case-by-case basis.

**Table 1 – Components of the Asbestos Removal Control Plan**

Information to be included in the asbestos removal control plan		Buildings and Structures		Plant and equipment		Friction products
		Friable	Non-friable	Friable	Non-friable	
<b>Identification</b>						
a	Details of the ACM to be removed (e.g. the location(s), whether it is friable or non-friable, type, condition and the quantity to be removed). See section 7.2.4.	✓	✓	✓	✓	✓
<b>Preparation</b>						
b	Consultation See section 7.1.					
c	Assigned responsibilities for the removal	✓	✓	✓	✓	✓
d	Program of commencement and completion dates	✓	✓	✓	✓	✓
e	Emergency plans See section 8.2.	✓	✓	✓	✓	✓
f	Asbestos removal boundaries, including the type and extent of isolation required and the location of any signs and barriers. See sections 9.1 and 9.2.	✓	✓	✓	✓	✓
g	Control of electrical and lighting installations See section 9.3.	✓	✓	✓	✓	-
h	Personal protective equipment (PPE) to be used, including respiratory protective equipment (RPE). See section 9.7.	✓	✓	✓	✓	✓
i	Details of air monitoring program. See section 9.8.	✓	-	✓	-	-
j	Waste storage and disposal program See section 9.10.	✓	✓	✓	✓	✓
<b>Removal</b>						
k	Methods for removing the ACM (wet or dry methods) See section 9.5.	✓	✓	✓	✓	✓
l	Asbestos removal equipment (spray equipment, asbestos vacuum cleaners, cutting tools, etc) See section 9.6.	✓	✓	✓	✓	✓
m	Details on required enclosures (see sections 10.1, 10.2 and 10.3), including details on their size, shape, structure, etc, smoke testing enclosures (see section 10.2.2) and the location of negative pressure exhaust units (see section 10.1).	✓	-	✓	-	-

Information to be included in the asbestos removal control plan		Buildings and Structures		Plant and equipment		Friction products
		Friable	Non-friable	Friable	Non-friable	
n	Details on temporary buildings required by the asbestos removalist (e.g. decontamination units) (see sections 10.1 and 10.2, including details on water, lighting and power requirements, negative air pressure exhaust units (see section 10.1) and the locations of decontamination units (see sections 10.2.3 and 10.2.4).	✓	-	✓	-	-
o	Other control measures to be used to contain asbestos within the asbestos work area.	✓	✓	✓	✓	✓
<b>Decontamination</b>						
p	Detailed procedures for workplace decontamination, the decontamination of tools and equipment, personal decontamination and the decontamination of non-disposable PPE and RPE. See section 9.9.	✓	✓	✓	✓	✓
<b>Waste disposal</b>						
q	Methods of disposing of asbestos wastes (see section 9.11), including details on the disposal of: <ul style="list-style-type: none"> <li>disposable protective clothing and equipment, and</li> <li>the structure(s) used to enclose the removal area</li> </ul>	✓	✓	✓	✓	✓
		✓	-	✓	-	-



## 8.2 Emergency plan

A site-specific emergency plan, reflecting the risks involved, should be developed before any asbestos removal work commences.

Workers should be trained for emergency situations. Decontamination procedures can be temporarily waived in the event of an emergency.

Emergency planning should include provisions for emergency and fire evacuation, including exit arrangements and emergency communications such as audible alarms. These alarms should be used for emergencies only.

Emergency exit arrangements need to be adequate for the risks involved. Barriers and signs or other warning devices can be used to communicate emergency arrangements.

A first aid kit and first aid officer should be readily available at all times, and sufficient suitable fire extinguishers and hoses should be available at strategic locations. The locations of fire extinguishers and hoses should be displayed in written and/or graphic format.

## 8.3 Planning for ACM removal from hot surfaces

If possible, the removal of asbestos from hot metal or machinery should be scheduled and planned around shutdowns, with sufficient time being allowed for the metal/machinery to cool.

Machinery should be cool before removal is attempted. The removal of friable ACM from hot metal presents one of the worst conditions for removal, because airborne asbestos fibres can readily spread on convection currents in the air. Hot metal removal should be used only in emergency situations.

Arrangements for the removal of asbestos from hot plant and equipment should be factored into the asbestos management plan described in the *National Code of Practice for the Management and Control of Asbestos in Workplaces* [NOHSC: 2018 (2005)]. This should include cooling requirements and/or the shutdown periods required to achieve adequate cooling.

In the limited circumstances where the dry removal of ACM from hot surfaces is the only option (i.e. emergency situations), particular care should be taken in the selection of dust extraction equipment to cope with the convection currents involved, and the selection of appropriate PPE also becomes much more important.

Heat stress must be considered when preparing the asbestos removal control plan, particularly in the selection of PPE and the design of the work program.

## 8.4 Planning for decontamination

The asbestos removalist should ensure that each site-specific asbestos removal control plan addresses any potential for asbestos-contamination and ensures this risk will be adequately controlled.

Notwithstanding this preventive emphasis, the asbestos removal control plan should also have provisions to ensure that any asbestos-contamination is promptly identified and rectified.

Decontamination requirements for personnel, tools and equipment, the asbestos work area and any other areas that could become contaminated need to be considered and addressed in the plan.

Section 0 of this code of practice provides information on specific decontamination procedures and section 10.2.3 provides information on decontamination units.

## **PART 9. GENERAL REQUIREMENTS FOR THE REMOVAL OF ACM FROM WORKPLACES**

The requirements in this Part 9 apply to the removal of all ACM (i.e. friable and non-friable) from workplaces. If friable ACM are to be removed, the additional requirements described in Part 10 are also required.

### **9.1 Determining the asbestos removal boundaries**

There are two 'asbestos removal boundaries' for asbestos removal work: the boundaries of the **asbestos work area** and the boundaries of the **asbestos removal site**.

The asbestos work area is the immediate area in which ACM removal work is taking place. The asbestos removal site is the region surrounding, and adjacent to, this asbestos work area.

The asbestos work area and the asbestos removal site should be clearly defined.

The boundaries of the asbestos work area and the asbestos removal site should be determined by a competent person and should be based on a risk assessment.

All interested parties must agree on the asbestos removal boundaries before any asbestos removal work may commence.

If a workplace and the type of asbestos removal work involved are both similar to those at a previously determined site, the same boundaries can be applied, after a reassessment for each site.

In determining the asbestos removal boundaries, consideration needs to be given to:

- the use and suitability of various types of enclosures and asbestos removal methods; and
- the impacts of the asbestos removal work, including potential exposures, in the surrounding region.

### **9.2 Security, signs and barriers**

Responsibilities for the security and safety of the asbestos removal site and asbestos work area should be specified in the asbestos removal control plan.

Where security and emergency arrangements are not developed specifically for the asbestos removal job, site-specific security and emergency plans should be provided prior to commencement of the works. Maintenance of site security and the prevention of unauthorised access should be designated in the asbestos removal control plan.

The responsible person should ensure the security and safety of the asbestos removal site and asbestos work area at all times, particularly if the removal process is to take place over several days or an extended period of time.

The asbestos removal site should be clearly defined to ensure that non-essential people do not enter and to clearly delineate the removal site and warn persons that asbestos removal work is being carried out (e.g. through the placement of barriers and signs or other warning devices). All barriers and warning signs should remain in place until a clearance to re-occupy has been granted (see **Part 11** of this code of practice).

Potential entry points to the asbestos work area should be signposted or labelled in accordance with AS1319-1994 *Safety Signs for the Occupational Environment*. **Appendix B** provides examples of asbestos warning labels and signs.

These signs should be weatherproof, constructed of light-weight material and adequately secured.

Tape can be used as a barrier to define an asbestos work area for some types of asbestos removal work of short duration. If a sign is not feasible, tape with the words 'asbestos hazard' along its length can be used instead to communicate the hazard.

In determining the distance between barriers and the asbestos work area the risk assessment should take account of:

- whether the ACM are friable or non-friable;
- activity around the asbestos work area (other workers, visitors, the public, etc);
- the methods of ACM removal;
- any existing barriers (walls, doors, etc);
- the quantity of ACM to be removed; and
- the type of barrier used (e.g. boarding or tape).

### **9.3 Electrical and lighting installations**

The risk of an electrical injury, particularly when water is involved, must be addressed prior to any ACM removal.

The best control is the de-energisation and removal of electrical installations from the asbestos work area.

If electrical installations cannot be disconnected and removed, they must, at the very least, be de-energised.

The de-energised installation must be tagged and locked out so it cannot be inadvertently re-energised. Any electrical cabling or equipment remaining in the asbestos removal area must be labelled and protected from mechanical damage or the ingress of water, and in accordance with AS/NZ 3000:2000 (wiring rules).

A licensed electrician must perform the safe removal and reinstallation of electrical cables and electrical equipment and ensure any electrical cabling or equipment is safe prior to re-energisation.

If there are fire detectors in the asbestos work area a competent person should isolate the circuits, as required, prior to the ACM removal.

Similarly, if there are smoke or thermal detector heads in the asbestos work area a competent person should remove the heads and isolate the circuits prior to any ACM removal work.

Upon the completion of the asbestos removal work a competent person should replace the heads, reactivate and test the system, prepare a certificate stating that the heads are operational and forward it to the person with control.

All portable electrical tools and equipment, including flexible leads, and any electrical installations utilised by workers during the asbestos removal should comply with AS/NZS 3012-2003 *Electrical Installations – Construction and Demolition Sites*.

## 9.4 Preparation

Preparation activities include minimising the number of people present and gathering the correct tools, PPE, decontamination materials, barricades, warning signs, etc at the workplace before any work commences.

Before removal tasks commence plastic sheeting (for containment) may need to be placed on the floor or other surfaces that may become contaminated with asbestos dust. If the removal work is not being carried out in an enclosure, the surfaces to be worked on should be cleaned, by either wet wiping or vacuuming (see section 9.9.1), to minimise exposure from the disturbance of asbestos fibres that might be on the surfaces prior to the commencement of removal tasks.

## 9.5 Wet and dry methods for removing ACM

Wherever possible, dry ACM should not be worked on.

Techniques that prevent the generation of airborne asbestos fibres should be used.

The following methods should be used for removing ACM, except when cleaning up asbestos-cement debris from soil, a task discussed in section 9.9.3.

### 9.5.1 Wet spray method (most preferred)

The ACM should be saturated through its full depth and maintained in a wet condition.

In many instances it is helpful if a wetting agent (surfactant), such as detergent, is added to the water, as this facilitates more rapid wetting of the ACM.

A manually controlled, consistent low pressure, coarse spray, such as from an adjustable pistol-grip garden hose, is recommended for this purpose.

The design of the spraying equipment will depend on the availability of a water supply and access to the area to be sprayed.

With this method, a water spray should be applied in a manner that:

- ensures the entire surface of the ACM is saturated; but

- minimises runoff.

While the water spray should be copious, it should not be so forceful that the water droplets generate dust when they hit the surface of the ACM.

When cutting equipment is being used to remove an ACM that is friable, the water spray should be directed at the site of the cut and the wetted material should be removed as the cut progresses.

The wetted ACM should be removed in sections, immediately placed in suitably labelled asbestos waste containers and properly sealed (see section 9.10). Any small sections that might be dislodged should be collected and properly disposed of as asbestos waste.

This is the preferred removal method.

It should only be used, however, if:

- the ACM is not covered with other materials such as calico or metal cladding, which require prior removal;
- there is no reinforcing wire or other similar restriction on removal;
- the ACM is not coated with paint or mastic;
- any rapid temperature drop caused by excessive water will not damage heated metal components; and
- no live electrical conductors are present and no damage to electrical equipment can arise from the ingress of water.

Although airborne asbestos fibres are significantly suppressed when the wet spray method is used, they are not entirely eliminated, so effective respiratory protection is also essential.

### ***9.5.2 Dry removal method (least preferred)***

The dry removal method should be used **only** if:

- the wet spray method is not suitable (e.g. if there are live electrical conductors or if major electrical equipment could be permanently damaged or made dangerous by contact with water); and
- prior approval has been obtained from the relevant State or Territory OHS authority (if this approval is required, as it is in some States and Territories).

There is a much greater potential for airborne asbestos fibres to be generated with the dry removal method than with the wet spray method.

Accordingly, if the dry removal method has to be used the following factors must be considered and employed, as determined by a risk assessment:

- The work area should be fully enclosed with plastic sheeting (at least 200 µm thick) and maintained at a negative pressure (at least 12 Pa water gauge).
- All personnel involved in the removal operation should wear full-face, positive pressure, supplied air respirators.

- The ACM should be removed in small, pre-cut sections with minimal disturbance, so as to reduce the generation of airborne asbestos fibres as much as possible.
- Waste material should be immediately placed in appropriate wetted containers.
- In some situations asbestos vacuum cleaners can be used to minimise airborne asbestos fibres. If it is possible to use asbestos vacuum cleaners, shadow vacuuming techniques should be employed. In order to achieve the required efficiency, the air speed at the extraction point should be at least 1 m/sec and the nozzle should be large enough and placed close enough (at a distance not more than the diameter of the nozzle) to provide efficient collection of airborne fibres.

## 9.6 Asbestos removal equipment

### 9.6.1 Tools

Care should be taken in selecting tools for asbestos removal tasks.

In addition to having to be suitable for these tasks, all tools should prevent or minimise the generation and dispersion of airborne asbestos fibres as much as possible.

The use of power tools in asbestos removal work should be avoided because of the possibility of internal contamination, which commonly occurs with such devices.

In general, manually operated hand tools are preferred.

If manually operated hand tools are not sufficient, low-speed battery powered tools, which may be used in conjunction with wet methods for dust control, are preferred

Battery-powered tools should be fitted with a local exhaust ventilation (LEV) dust control hood wherever other dust control methods (e.g. use of wet removal methods) are determined to be unsuitable. Consideration should be given to the use of shadow-vacuuming techniques if a LEV dust control hood can not be attached and no other dust control method is used.

Some State and Territory OHS authorities prohibit the use of power tools in certain circumstances, so the relevant authority should be consulted before power tools are used.

At the end of the removal work, all tools should be:

- Decontaminated (i.e. fully dismantled and cleaned under controlled conditions as described in section 9.9.2), or
- Placed in sealed containers (and used only for asbestos removal work); or
- Disposed of as asbestos waste.

**Warning:** High-speed abrasive power or pneumatic tools such as angle grinders, sanders, saws and high speed drills *must* never be used.

### **9.6.2 Spray equipment**

A constant low-pressure water supply is required for wetting down asbestos. This can be achieved with a mains-supplied garden hose fitted with a pistol grip. If no water supply is readily available, a portable pressurised vessel, such as a pump-up garden sprayer, may be able to be used.

**Warning:** High-pressure spray equipment *must* never be used.

### **9.6.3 Asbestos vacuum cleaners**

Asbestos vacuum cleaners should comply with the requirements of AS 3544-1988 *Industrial Vacuum Cleaners for Particulates Hazardous to Health* and AS 4260-1997 *High Efficiency Particulate Air Filters (HEPA) – Classification, Construction and Performance*.

**Warning:** Domestic vacuum cleaners are unsuitable and should never be used, even if they have a HEPA filter.

Asbestos vacuum cleaners should only be used for collecting small pieces of asbestos dust and debris. Larger pieces should never be broken into smaller sizes so they can be vacuumed.

Asbestos vacuum cleaners should not be used for vacuuming wet materials because this can damage the HEPA filter.

Use the correct attachment to the asbestos vacuum cleaner for the type of surface you are cleaning.

Procedures should be established for the general maintenance of asbestos vacuum cleaners in a controlled environment. They should be cleaned externally with a wet cloth after each task, the hose and attachments should be stored in a labelled impervious bag and a cap should be placed over the opening to the asbestos vacuum cleaner when the attachments are removed.

PPE should be worn whenever an asbestos vacuum cleaner is opened to change the bag or filter or to perform other maintenance or decontamination (see section 9.7).

The emptying of asbestos vacuum cleaners can be hazardous if the correct procedures are not followed. Asbestos vacuum cleaners should only be emptied by a competent person with the correct PPE, in a controlled environment and in compliance with the manufacturer's instructions.

Whenever possible, asbestos vacuum cleaners should not be hired, as they can be difficult to fully decontaminate.

If hiring is necessary, they should be hired only from organisations that provide vacuum cleaners specifically for work with asbestos.



The asbestos vacuum cleaner should be hired out in a sealed storage container, with instructions that it may be removed from the container only when it is inside the asbestos work area and users are wearing appropriate PPE.

When the work is completed, the asbestos vacuum cleaner should be decontaminated — with the bag and filter being removed in accordance with the manufacturer's instructions and disposed of as asbestos waste, and the inside and outside of the vacuum cleaner being wet wiped — and the asbestos vacuum cleaner should be re-sealed in the storage container provided. The sealed storage container should then be decontaminated by wet wiping before being removed from the asbestos work area and returned to the hire organisation.

Organisations that hire out asbestos vacuum cleaners must ensure that all their asbestos vacuum cleaners, filters and bags are maintained in good working order and that the hirers are competent in their safe use.

### ***9.6.4 Inspection of equipment***

All equipment used for the removal of ACM should be inspected before the commencement of the removal work, after any repairs and at least once every seven days when it is continually being used.

A register with details of these inspections, the state of the equipment and any repairs should be maintained.

## **9.7 Personal protective equipment (PPE)**

### ***9.7.1 Respiratory protective equipment***

All persons engaged in asbestos removal work should wear respiratory protective equipment (RPE) conforming with the requirements of AS/NZS1716-2003 *Respiratory Protective Devices*.

The selection, use and maintenance of respirators should be in accordance with AS/NZS 1715-1994 *Selection Use and Maintenance of Respiratory Protective Devices*.

Respirators should be issued to individuals for their exclusive use. A system of regular cleaning, inspection and maintenance should be provided for respirators on extended personal issue, and records of all respirator issues and uses should be established and maintained.

The level of respiratory protection required (e.g. P1, P2 and P3 supplied air respirators) should be determined by a competent person in accordance with the asbestos removal task to be undertaken. **Appendix C** provides for more information on the selection of suitable respiratory protection for particular removal tasks.

Systems of work should be established for the cleaning, maintenance and storage of respirators in accordance with AS/NZS 1715. Respirators should be maintained in a clean and good working condition by the person designated by the supervisor of the removal job to look after and be responsible for the safe working condition of respiratory equipment.

Respirator defects should be reported immediately to the supervisor of the removal job for repair or replacement.

Workers should receive instruction and training in the correct method of using their respirators, the importance of a correct facial fit and the requirements of the system of regular cleaning, inspection and maintenance.

All workers should undergo a 'fit test' in order to determine their suitability to wear negative pressure respirators. Persons with beards or other facial hair or stubble will not be protected properly by 'negative pressure' respirators that require a facial seal, so all asbestos removal workers using respirators that require a facial seal should be clean-shaven.

If a medical condition precludes the use of negative pressure respirators, individuals should be provided with a continuous flow, positive pressure respirator wherever possible. The suitability of these individuals for work in the asbestos removal industry should be assessed by a qualified medical practitioner.

Persons requiring the use of prescription spectacles may not be able to use full-face respirators, because of the loss of seal around the spectacle arms. If their spectacles cannot be modified so that they do not need the support of the ears, these people should not use full-face respirators and should wear air supply hoods instead. It is important, however, to be sure these hoods will provide a sufficient level of protection.

Where air-lines are used, the air-line should incorporate a belt mounted back-up filter. Where a failure of the air supply system occurs, workers should leave the work area using normal decontamination procedures. The use of a back up belt mounted filter device allows for adequate respiratory protections during this process.

If the number of workers wearing air-line respirators inside an enclosure is likely to result in the tangling of air lines, manifolds should be provided to reduce this tangling and assist workers in moving around the enclosure. The capacity of the compressor should be adequate for the number of air lines, and the location of the compressor's air intake should be assessed to ensure appropriate air quality and avoid contamination.

A competent person may change the level of respiratory protection at any stage during the removal process following a thorough assessment of the fibre levels actually experienced inside the asbestos work area. Typically, this may occur during the final clean-up after the removal of friable ACM, when the use of air lines is no longer considered necessary.

All filters used while working with asbestos should be disposed of as asbestos waste (see sections 9.10 and 9.11).

### ***9.7.2 Protective clothing and footwear***

Protective clothing should be provided and worn at all times during all work in the asbestos work area prior to the final clearance inspection.

Protective clothing should be made from materials which provide adequate protection against fibre penetration. Coveralls should not have external pockets or velcro fastenings because these features are easily contaminated and difficult to decontaminate.

Disposable coveralls are preferred. They should never be reused, and must be disposed of as asbestos waste.

In some limited circumstances — for example, if there is a fire hazard — disposable protective clothing is not appropriate and re-usable types may be used.

Laundering of asbestos contaminated protective clothing is not recommended, because decontamination cannot be guaranteed. The otherwise reusable coveralls etc should instead be disposed of as asbestos waste.

If re-usable protective clothing is to be laundered, notwithstanding these recommendations, the clothing should be completely wetted before it is double bagged and sent to a laundering facility capable of laundering asbestos contaminated clothing. In some States and Territories notification requirements apply. **The laundering of contaminated protective clothing in workers' homes is strictly prohibited.**

Clothing made from wool or other materials that attract fibrous dusts should not be worn in the asbestos removal site.

Special attention should be paid to the risks of heat stress from working in very hot environments. A competent person should determine the most suitable protective clothing and decontamination procedures for workers in these situations.

The use of protective gloves should be determined by a risk assessment. If significant quantities of asbestos fibres may be present, disposable gloves should be worn. Protective gloves can be unsuitable, however, if dexterity is required. All gloves used for asbestos removal work must be disposed of as asbestos waste.

Regardless of whether gloves are used, asbestos removal workers must clean their hands and fingernails thoroughly after work.

Appropriate safety footwear (i.e. steel-capped rubber-soled work shoes or gumboots) should be provided for all asbestos removal workers. This footwear should be laceless, because laces and eyelets are easily contaminated, and should remain inside the asbestos work area or dirty decontamination area for the duration of the asbestos removal work. When not in use, the safety footwear should be stored upside down to minimise asbestos-contamination inside the footwear. Storage facilities should be provided to allow this.

Safety footwear must be decontaminated at the end of the job and upon leaving the work area, or sealed in double bags for use on the next asbestos removal site (but not for any other type of work). Work boots cannot be effectively decontaminated must be disposed of as asbestos waste.

## 9.8 Air monitoring

Air monitoring should be performed whenever ACM are being removed, to ensure the control measures are effective.

In most cases only control monitoring, rather than exposure monitoring, is required, because the risks to all asbestos removal workers should already have been assessed and effective respiratory protection etc should already be provided.

Air monitoring requirements will vary, however, depending on the types of ACM being removed, the location and position of the ACM, the need for and use of enclosures and whether the removal work is within a building or outside.

A competent person, who is independent from the person responsible for the removal work, should determine all air monitoring requirements. Among other things, they should decide:

- the location, rate and frequency of sampling;
- whether is necessary to monitor air quality in areas adjacent to, above and below the asbestos work area, taking account of the potential exposures of occupants of these areas; and
- whether additional routine air sampling is warranted in (for example) nearby high-occupancy areas.

Written air monitoring programs should be developed by this competent person for all indoor removals of friable ACM, and also for all outdoor removals of friable ACM where there might be a risk to other persons.

The air monitoring program should include requirements for clearance monitoring (see section 11.2).

Although an air monitoring program is not always necessary for the removal of non-friable ACM, it is nonetheless good occupational hygiene practice.

Air monitoring should be performed in accordance with the NOHSC *Guidance Note on the Membrane Filter Method for Estimating Airborne Asbestos Fibres* [NOHSC:3003 (2005)].

Asbestos removal work must not commence until the air monitoring has commenced.

Static air samplers should generally be placed in the middle of the sampling area, away from areas where there may be poor air mixing (e.g. close to walls, corners or large objects) or fast air movements (e.g. in front of air-conditioning inlets or exhausts).

If an enclosure is used, air monitoring should occur:

- prior to any work (background monitoring);
- at least daily at the boundary of the asbestos work area;
- as part of preliminary clearance monitoring, following a satisfactory visual inspection (see **Part 11** of this code of practice);
- during dismantling of the enclosure, and
- as part of the final clearance inspection.

If an enclosure and a decontamination unit are used, air quality should be monitoring at the following locations:

- the clean side of the decontamination unit;

- the change area;
- the lunch room (where applicable);
- the laundry; and
- the surroundings of the asbestos work area including in the vicinity of the negative air exhaust (where possible).

**Note:** *Air monitoring of the exhaust from the extraction unit is a specialised task. The membrane filter method (MFM) is unsuitable, because the results obtained do not always truly reflect actual fibre concentrations in the exhaust air, and air monitoring devices should not be positioned at the exit point of a negative pressure exhaust air unit, because this can lead to unwarranted confidence in the filter's integrity. If the exhaust is to be monitored directly, isokinetic sampling techniques should be used.*

The results of all air monitoring should be provided to all relevant parties as soon as possible.

The relevant State or Territory OHS authority should be consulted for further information on air monitoring requirements.

### **9.8.1 'Control levels' for monitored airborne asbestos fibres**

'Control levels' are airborne asbestos fibre concentrations which, if exceeded, indicate there is a need to review current control measures or take other action.

These control levels are occupational hygiene 'best practice', and are not health-based standards (they are below the concentration set in the NES for asbestos).

The control levels shown in **Table 2** should be used for the purposes of determining the effectiveness of control measures:

**Table 2 – Control levels and required actions**

<b>Control level (airborne asbestos fibres/mL)</b>	<b>Control / Action</b>
< 0.01	Continue with control measures
≥ 0.01	Review control measures
≥ 0.02	Stop removal work and find the cause

## **9.9 Decontamination**

The type of decontamination required will depend on the type of asbestos (i.e. friable or non-friable); the work method used (see section 9.5), and site conditions

Decontamination must include the asbestos work area, all tools and equipment and personal decontamination.

All contaminated materials, including cleaning rags, plastic sheeting and PPE etc, must be disposed of as asbestos waste.

Some asbestos removal work necessitates the use of decontamination units. For details, see sections 10.2.3 and 10.2.4.

### ***9.9.1 Workplace decontamination***

Any asbestos dust or debris must be collected in a safe manner and the asbestos work area decontaminated, paying attention to all walls, ledges, fittings and furnishings.

Two types of decontamination procedures may be used: wet and dry decontamination:

**Wet decontamination**, or **wet wiping**, involves the use of damp rags to wipe down contaminated areas. Cleaning rags should only be used once, although they may be re-folded to expose a clean surface. The rags should be used flat and should not be wadded. If a bucket of water is used, the rags should not be re-wetted in the bucket, as this will contaminate the water. Care should be taken to avoid any potential electrical hazards when using this procedure.

**Dry decontamination** should be only used where wet methods are not suitable or pose a risk because of other hazards such as electricity or slipping. Dry decontamination procedures include carefully rolling or folding up and sealing plastic sheeting and/or vacuuming the asbestos work area with an asbestos vacuum cleaner. Large pieces of asbestos debris should be wetted and picked up by hand rather than vacuumed.

Whenever the asbestos work area cannot be decontaminated using either the wet or dry method — for example, if there is rough sawn wood that cannot be fully decontaminated by wet wiping or vacuuming — pigmented polyvinyl acetate (PVA) may be used to seal the contaminated sections of the asbestos work area, including any plant or equipment where practicable.

### ***9.9.2 Decontamination of equipment and tools***

All tools and equipment used during the removal task should be decontaminated using either the wet or dry decontamination procedures described above, before they are removed from the asbestos work area. The method chosen should depend on its practicality and the presence of any electrical hazards.

If tools and equipment cannot be decontaminated in the asbestos work area, or are to be reused at another asbestos work area, they should be tagged to indicate asbestos contamination and double bagged in asbestos waste bags before being removed from the asbestos work area. This equipment and tools must remain sealed until decontamination or the commencement of the next asbestos maintenance or service task where the equipment can be taken into the work area and reused under full control conditions.

PPE should be worn when opening the bag to clean or re-use the equipment or tools, and decontamination should only be performed in a controlled environment.

Bags containing asbestos contaminated equipment and tools should be clearly labelled with an appropriate warning statement.

### ***9.9.3 Decontamination of soil***

In some circumstances soil can become contaminated with ACM. This can occur, for example, during the removal of ACM, at landfill sites or if the ACM are damaged.

If there is a risk of soil contamination the area should be visually inspected, and if any ACM are detected the soil must be decontaminated.

The methods used for this decontamination should be based on a risk assessment. The use of professional site remediation advice and/or services should be considered.

During soil decontamination the topsoil should be dampened down, to minimise the generation of dust, and all visible pieces of ACM debris should be picked up individually, so that the risk of asbestos fibre inhalation is effectively eliminated.

If this is not practicable, the contaminated topsoil should be removed to a depth that has no visible contamination or asbestos debris.

The contaminated soil must be disposed of as asbestos waste.

### ***9.9.4 Personal decontamination***

Personal decontamination must be undertaken each time workers leave the asbestos work area and at the completion of the asbestos maintenance or service work. Personal decontamination should be done within the asbestos work area where re-contamination cannot occur.

Asbestos-contaminated PPE should not be transported outside the asbestos work area except for disposal purposes.

Before work clothes and footwear worn during asbestos work are removed from the asbestos work area for any reason, they should be thoroughly vacuumed with an asbestos vacuum cleaner to remove any asbestos fibres (see section 9.6.3), and the footwear should also be wet wiped.

Respiratory protective equipment should be used until all contaminated disposable coveralls and clothing has been vacuum cleaned and/or removed and bagged for disposal, and personal washing has been completed.

Any PPE used while carrying out asbestos work must not be taken home.

Personal hygiene and careful washing are essential. Particular attention should be paid to the hands, fingernails, face and head.

If **friable ACM** are being removed, the decontamination procedures described in section 10.2.6 must be followed.

However, if only small quantities of **non-friable ACM** are being removed, a competent person may decide, on the basis of a risk assessment, that the following personal decontamination procedure can safely be used, instead of a full decontamination unit:

- First, all visible asbestos dust/residue is removed from protective clothing, using an asbestos vacuum cleaner and/or wet wiping.
- Second, the protective clothing is taken off (while still using a respirator) and placed in an asbestos waste bag.  
(As discussed in section 9.7.2, disposable protective clothing is preferred. If non-disposable clothing is used, it should be completely wetted before double bagging, labelled and sent to a laundering facility capable of laundering asbestos-contaminated clothing. In some States and Territories notification requirements apply. **The laundering of contaminated protective clothing in workers' homes is strictly prohibited.**)
- Third, clothing and footwear worn during the removal should be vacuumed using an asbestos vacuum cleaner and the footwear should also be wet wiped.
- Disposable respirators should then be discarded as asbestos waste. Non-disposable respirators should be removed and thoroughly cleaned.
- After removing the respirator, workers should wash their face and hands, paying particular attention to their fingernails.

This form of personal decontamination *might* be suitable, for example, following the removal of:

- an asbestos gasket;
- an asbestos (zelemite) electrical switchboard;
- small amounts of asbestos-cement sheeting or vinyl floor covering;
- minor amounts of asbestos debris;
- asbestos-cement conduits and in-ground surface pits; or
- asbestos friction materials.

However, some of these forms of ACM could be friable, making more extensive decontamination procedures necessary. The measures adopted should always address the risks of each individual asbestos removal job.

## **9.10 Waste removal**

### ***9.10.1 Waste disposal program***

A waste disposal program should be developed, taking account of:

- waste containment,
- the location for waste storage on site,



- the transport of wastes within the site and off-site,
- the location of the waste disposal site,
- approvals needed from the relevant local disposal authority,
- any local disposal authority requirements that may apply to the amount and dimensions of asbestos waste, and
- any state or territory requirements that may apply to the amount and dimensions of asbestos waste.

Loose asbestos waste should not be allowed to accumulate within the asbestos work area.

Asbestos waste may be collected and disposed of in an asbestos waste bag (see section 9.10.2), a drum or bin (see section 9.10.3) or a waste skip (see section 9.10.4).

If asbestos waste cannot be disposed of immediately (e.g. because of volume requirements for disposal), it should be stored in a solid waste drum, bin or skip and sealed and secured upon the completion of each day's work so that unauthorised access is prevented.

### **9.10.2 Waste bags**

Asbestos waste should be collected in heavy-duty 200 µm (minimum thickness) polythene bags that are no more than 1200 mm long and 900 mm wide.

The bags should be labelled with an appropriate warning, clearly stating that they contain asbestos and that dust creation and inhalation should be avoided.

An example of a warning statement which might be used is:

**CAUTION – ASBESTOS  
DO NOT DAMAGE OR OPEN BAG  
DO NOT INHALE DUST  
CANCER AND LUNG DISEASE HAZARD**

Controlled wetting of the waste should be employed to reduce asbestos dust emissions during bag sealing or any subsequent rupture of a bag.

Only unused bags should be used, and bags marked for asbestos waste should not be used for any other purpose.

Hard and sharp asbestos waste requires preliminary sealing or a protective covering before it is placed in the waste bags, to minimise the risk of damage to the bags.

In order to further minimise the risk of a bag's tearing or splitting, and also to assist in manual handling, asbestos waste bags should not be filled more than half full and excess air should be gently evacuated from the waste bag, in a manner that does not cause the release of dust.

The bags should then be twisted tightly, folded over and the neck secured in the folded position with adhesive tape or any other effective method.

The external surface of each bag should be cleaned to remove any adhering dust before the bag is removed from the asbestos work area.

All asbestos waste should be double bagged outside the work area immediately following the decontamination process.

The routes used for removing waste from the asbestos work area should be designated in the asbestos removal control plan before the commencement of each removal. The methods used to transport wastes through a building should be determined by a competent person following discussions with the asbestos removalist. In occupied buildings, all movements of waste bags should be outside normal working hours.

Once the waste bags have been removed from the asbestos work area, they should either:

- be placed in a solid waste drum, bin or skip (see sections 9.10.3 and 9.10.4); or
- be removed from the site by an approved and licensed carrier.

Waste bags should not be stored at the asbestos removal site if they are not placed in an asbestos waste drum, bin or skip.

If a decontamination unit is being used for the asbestos removal work (see sections 10.2.3 and 10.2.4), asbestos waste bags should be removed from the asbestos work area through the decontamination unit using the following 'production line' operation:

- One worker is located in each section of the decontamination unit.
- The waste bags are passed from cubicle to cubicle and 'showered out' to remove any asbestos residue.
- Once they have been removed from the decontamination unit, the waste bags are double bagged prior to disposal.

### **9.10.3 Asbestos waste drums or bins**

All drums or bins used for the storage and disposal of asbestos waste should be in a good condition, with lids and rims in good working order, and free of hazardous residues.

The drums or bins should be lined with plastic (minimum 200 µm thickness), and labels warning of the asbestos waste should be placed on the top and side of each drum or bin, with the words, 'Danger: asbestos. Do not break seal' or a similar warning.

If the drum or bin is to be re-used, the asbestos waste must be packed and sealed so that when the drum or bin is emptied there is no residual asbestos contamination.

Controlled wetting of the waste should be used to reduce asbestos dust emissions.

Where possible, the drums or bins should be placed in the asbestos work area before work on ACM begins. The drums or bins should have their rims sealed and their outer surfaces wet wiped and inspected before they are removed from the asbestos work area.

If it is not possible to locate the drums or bins inside the asbestos work area, they should be located as close to the work area as possible. Routes for moving the waste from the asbestos work area to the waste drums or bins should be designated prior to the commencement of each task. A competent person should decide the best means of moving the waste through the building. In occupied buildings, all movement of bags from the work area to the waste drums or bins should be performed out of normal working hours.

Drums or bins used to store asbestos waste should be stored in a secure location when they are not in use.

Drums or bins should not be moved manually once they have been filled. Trolleys or drum lifters should be used.

Vacuum suction (Super Suckers) may be used to collect removed ACM. A competent person should assess the process to prevent asbestos-contamination. Air from the vacuum system must pass through a HEPA filter before it is released outside the asbestos work area.

#### **9.10.4      *Asbestos waste skips etc***

If it is not feasible to use asbestos waste bags, drums or bins, because of the volume or size of the asbestos wastes, a waste skip, vehicle tray or similar container may be used.

Skips should be in good condition.

The ACM should be sealed in double-lined, heavy-duty plastic sheeting or double bagged before they are placed in the skip. However, non-friable asbestos waste may be placed directly into a skip or vehicle tray that has been double lined with heavy-duty plastic sheeting (200 µm minimum thickness), provided it is kept damp to minimise the generation of airborne asbestos fibres.

Once the skip is full its contents should be completely sealed with the plastic sheeting.

If the skip is to be used for storing the asbestos waste its contents must be able to be secured (e.g. using a lockable lid).

### **9.11      Disposal of asbestos waste**

All asbestos waste should be removed from the workplace by a competent person and transported and disposed of in accordance with all relevant State or Territory legislation and guidelines for the transport and disposal of asbestos waste.

In some States and Territories a licence from environmental and/or waste disposal authorities is required for the transport and disposal of asbestos waste.

Further information on the transport and disposal of asbestos waste, including licensing requirements and designated asbestos waste dumps, may be obtained from local councils or the relevant environmental protection authority or waste disposal authority.

## **9.12 Recycling of construction materials**

Before any building materials are recycled, procedures need to be established to ensure asbestos-contaminated materials are not reused unless they have been successfully decontaminated.

These procedures should include the quarantining of incoming building materials that are intended for recycling to:

- allow screening these materials for asbestos-contamination before they are distributed within the recycling yard; and
- enable the removal of contaminated building products to prevent their re-distribution.

## **PART 10. ADDITIONAL REQUIREMENTS FOR THE REMOVAL OF FRIABLE ACM**

The methods used to remove ACM must prevent the release of asbestos fibres into the atmosphere, both during and after the removal operation.

Choices of removal methods will therefore depend on the nature, condition, quantity and location of the ACM and any other health or safety hazards present.

This **Part 10** of this code of practice describes the controls commonly required for the removal of friable ACM, *in addition to* the controls required for *all* asbestos removals, already described in **Part 9**.

ACM that are friable should be removed using wet methods, wherever possible, and within an enclosed area. Methods for enclosing work are described in this **Part 10**.

In addition,

- all ventilation and air-conditioning networks servicing the asbestos work area should be closed down for the duration of the asbestos removal work and all vents thoroughly sealed to prevent the entry of airborne asbestos fibres into the duct network;
- upon completion, and after final cleaning of the asbestos work area, all mechanical ventilation filters for recirculated air should be replaced; and
- care should be taken to ensure that airborne asbestos fibres cannot escape at points where pipes and conduits pass out of the asbestos work area (greater attention to sealing and testing is required in these regions, particularly if service riser shafts pass through the asbestos work area).

The methods described below are commonly used for the removal of sprayed asbestos thermal and acoustic insulation from buildings and structures and the removal of ACM from plant and equipment, including steampipes, boilers and other industrial plant.

### **10.1 Negative pressure exhaust units**

To prevent the escape of airborne asbestos fibres from an enclosed asbestos work area, an exhaust extraction fan should be installed so as to create a 'negative' air pressure of approximately 12 Pa (water gauge) within the enclosed asbestos work area.

Ideally, the negative pressure exhaust unit should be positioned opposite the decontamination unit to enable laminar (smooth) air flow. In this arrangement, most of the air entering the asbestos work area passes through the decontamination unit or point of entry, while the air extracted by this system passes through a HEPA filter to remove any asbestos dust before it is discharged to the outside atmosphere at a location distant from other working areas, air-conditioning inlets or breathing air compressors.

The extraction equipment should be operated continuously (i.e. 24 hours a day) until all asbestos removal and decontamination tasks within the enclosure have been completed.

The HEPA filter must comply with AS 4260:1997 *High Efficiency Particulate Air Filters (HEPA) – Classification, Construction and Performance*. A coarse pre-filter should be installed on the air intake side of the negative air unit to prolong the useful life of the HEPA filter.

Procedures should be established for changing these HEPA filters so that areas outside of the enclosure are not contaminated.

The most satisfactory method for assessing the integrity of the HEPA filter and seal fittings is regular inspection, in conjunction with a static pressure alarm to indicate any failure in the system.

## **10.2 Enclosures for large-scale asbestos removal work**

Wherever practicable, enclosed 'negative pressure' asbestos work areas should be established for any large-scale removal of friable ACM.

Similar large enclosures can also be used for the removal of non-friable ACM, if a risk assessment concludes that enclosure is an effective control for the risks involved.

The design and installation of the enclosure should take account of:

- the methods used to contain the asbestos work area;
- the provision and locations of decontamination and changing facilities;
- the precautions which must be implemented to prevent the spread of asbestos-contamination outside the asbestos work area;
- air quality within the enclosure (e.g. there must always be sufficient oxygen, and machinery emitting any fumes or potentially dangerous gases must be placed outside the enclosure, well away from any intake for the enclosure);
- the temperature within the enclosure (especially to avoid heat stress); and
- any other hazards in the enclosure (these must be identified and control measures established before any asbestos removal work commences).

Work methods may also need to be adapted for the work environment within the enclosure. For example, rest breaks should be based a risk assessment, taking account of factors such as the weather and heating/cooling requirements.

### **10.2.1 The enclosure**

Heavy-duty plastic sheeting (200 µm minimum thickness) should be used for the enclosure. Re-milled plastic must not be used.

Every location where the asbestos work area connects to the outside environment or the rest of the building (e.g. windows, ducts, wall cavities, conduits and lift entrances) should be enclosed, so that an airtight seal is maintained for the duration of the asbestos removal work.

The plastic sheeting should enclose all the walls, windows and doors. Wooden cleats may be able to be used to anchor the plastic sheeting to walls.

Viewing panels should be placed in appropriate locations.

Adequate lighting needs to be provided within the enclosure, either naturally, using clear plastic or perspex panels in the enclosure walls, or artificially, preferably from outside the enclosure and again using clear plastic or perspex panels. Lights within an enclosure can increase the temperature within the enclosure.

All non-movable items (i.e. fixtures and fittings) should be covered with plastic sheeting and all the joints sealed.

All movable items should be removed from the asbestos work area or, if this is not possible, moved to a convenient location and covered with two layers of plastic sheeting, with a minimum overlap of 300 mm between the layers. Both of these layers should be double taped.

Air locks should be provided at the entry points to the change area. These air locks should be constructed using double sets of overlapping plastic, with suitable provisions for ensuring a seal.

All floors should be protected with at least one layer of woven plastic. It is important for penetration to be prevented. The joints should be lapped 300 mm and sealed with double-sided tape and duct tape.

Ceiling spaces may be sealed by constructing a plastic-lined frame within the ceiling space. This frame should be removed only after completion of the final clearance inspection.

If the asbestos work area is adjacent to areas occupied by unprotected persons, priority should be given to performing the removal work during periods when these areas are unoccupied or to a greater isolation of the removal area. In addition, hoarding should be constructed to form a barrier between the asbestos work area and the adjoining occupied areas. A plastic-lined barrier should be erected within this hoarding. A buffer area should be reserved between the hoarding and the occupied areas.

Any platforms and/or fixed scaffolding required for the safe removal of the ACM should be erected during the early stages of the work. Ideally these structures should be erected on the outside of the enclosed area. However, where it is necessary, to construct platforms and or fixed scaffolding within the enclosed area, decontamination and visual inspection of these structures will be necessary at the end of the removal work.

During the masking up and later removal of the screening, all persons involved should wear appropriate PPE and as a minimum, a half face respirator with a P1 or P2 filter.

All tools and electrical equipment, including asbestos vacuum cleaners and power tools, should remain within the asbestos work area until the completion of the removal work. When this equipment is removed it should be decontaminated as described in section 0.

All the plastic, tape, etc used for the enclosure must be disposed of as asbestos waste.

### **10.2.2      *Testing the effectiveness of the enclosure***

When the asbestos removalist is satisfied that the enclosure is complete, a competent person should carry out a visual inspection and smoke test prior to the commencement of the asbestos removal work.

The asbestos removalist should notify the client before the visual inspection and smoke test, giving them adequate notice.

Negative pressure exhaust units should not be used while the smoke test is being conducted. Only smoke generating devices incorporating non-oil-based, non-toxic smoke fluids should be used. Flares should not be used. Smoke (fire) detection devices in the immediate vicinity of the work area should be isolated for the duration of the smoke test.

Work should not proceed if any leaks or other deficiencies in the enclosure are found during the testing.

The effectiveness of the enclosure should be regularly monitored while asbestos removal work is underway.

If air monitoring or visual examinations of the enclosure and items of equipment indicate that asbestos dust might be escaping from the enclosure, asbestos removal work should be stopped until any defects have been rectified.

Following any such an incident, before work recommences it is essential to:

- identify the source of the leak(s);
- prevent further release of fibres;
- re-test the enclosure;
- clean any contaminated areas;
- conduct a visual inspection;
- conduct monitoring tests specific to the incident (see section 9.8);
- notify the relevant State or Territory OHS authority, where applicable; and
- reassess the boundaries of the asbestos work area and asbestos removal site.

Persons investigating a leak must use appropriate PPE.

Any leaks in the enclosure should be sealed and the smoke test repeated until the enclosure is shown to be effectively sealed again.

A supply of expandable foam sealant, polyester insulation or equivalent should be maintained on the site to aid in sealing leaks.

### **10.2.3      *Decontamination unit***

In many instances, the only satisfactory way of providing appropriate changing facilities is to provide a mobile or specially constructed on-site decontamination unit.

This decontamination unit should be immediately adjacent to, and directly connected with, the enclosed asbestos work area.



It should be divided into three distinct areas:

- a **dirty decontamination** area;
- a **clean decontamination** area; and
- a **clean changing** area.

These areas should be separated by suitable airlocks or buffer zones.

Normally these airlocks have spring-loaded doors, or two or more overlapping sheets of plastic sheet, positioned so as to define the boundary between each segment of the decontamination unit, while allowing personnel access and an airflow towards the asbestos work area. To ensure there is sufficient airflow through the decontamination unit, if doors are used they should have large openings with a hinged flap operating as a one-way valve.

A typical layout is shown in **Figure 1**.

No more than six persons should use any one decontamination unit.

The dirty decontamination area should provide for:

- vacuum cleaning or hosing down of contaminated clothing and footwear;
- the storage of contaminated clothing and footwear;
- labelled waste bags/bins for disposable protective clothing; and
- a shower area with an adequate supply of warm water.

The clean decontamination area should provide for:

- the storage of individual respirators in containers or lockers;
- airflow towards the dirty decontamination area; and
- a shower area with an adequate supply of warm water.

The clean changing area should provide for:

- the storage of clean clothing;
- separate storage of clean and dirty towels; and
- airflow towards the clean decontamination area.

All water from the decontamination facility should pass through a high efficiency particulate filter or other trap before it passes into sewer mains. The filter or trap must be capable of capturing particles down to 5µm.

Workers must not smoke, eat or drink in any part of the decontamination unit.

Figure 1

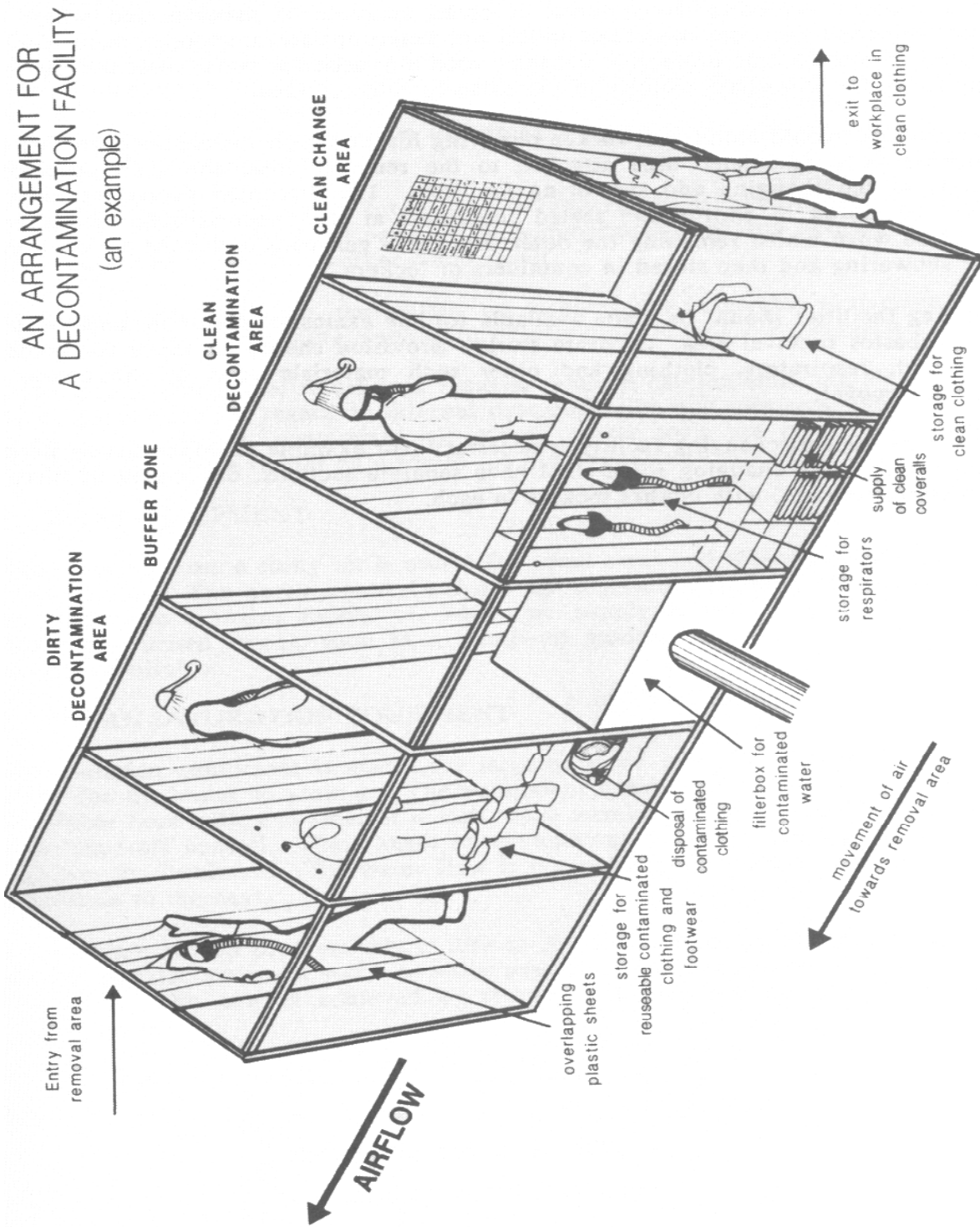

### **10.2.4 Remote decontamination units**

Remote decontamination units are decontamination units that are not located next to the asbestos work area.

They should only be used if a decontamination unit *cannot* be located immediately adjacent to the asbestos work area.

When a remote decontamination unit is to be used, the asbestos removalist may need to implement additional procedures to minimise asbestos-contamination, including methods for the connection and disconnection of air-line respirators.

The route of access from the asbestos work area to the decontamination unit should be suitably signposted and barricaded to restrict public access.

Control monitoring must be conducted in the immediate vicinity of this access route and at other suitable locations outside the asbestos work area.

An **isolated changing area** should be attached to the asbestos work area. Before workers enter this changing area, all obvious signs of asbestos dust should be removed from their protective clothing using an asbestos vacuum cleaner. The isolated changing area is then used to discard outer garments, including coveralls and overshoes, and to dress in fresh outer/protective clothing for the journey to the decontamination unit.

Respiratory protection should continue to be worn until the appropriate phase of the decontamination procedure within the remote decontamination unit.

### **10.2.5 Entering the asbestos work area**

The procedure for persons entering the asbestos work area should be as follows:

- a) **Clean change area:** Change into clean work clothes and put on clean protective clothing. Store any removed clothing in a dust-proof container. Pass through the airlock into the clean decontamination area.

Adequate supplies of undergarments and socks (disposable or reusable) should be provided for all personnel entering the asbestos work area. Adequate supplies of shorts and t-shirts should also be made available to all workers.

- b) **Clean decontamination area:** Put on respirator. Check that it is working properly and there is a good facial seal. Move to the dirty decontamination area.
- c) **Dirty decontamination area:** Put on any additional protective equipment that has been stored in the dirty decontamination area, such as footwear. Connect to the air supply. Pass out of the decontamination unit into the asbestos work area.

### **10.2.6      *Decontamination procedures***

The decontamination procedure for persons leaving the asbestos work area should be as follows:

- a) **Asbestos work area:** Use an asbestos vacuum cleaner to remove any obvious signs of asbestos dust from protective clothing. Remove footwear and leave shoes/boots inside the asbestos work area, adjacent to the decontamination unit (footwear should be stored upside down to minimise further contamination). Proceed into the dirty decontamination area.
- b) **Dirty decontamination area:** If shoes/boots have not already been removed, remove them and store them (upside down) within the dirty decontamination area. Disconnect air-line respirator. Shower while wearing protective clothing and respirator. Leaving the respirator on, remove protective clothing and place it in labelled waste bags. Remove wet underclothing, such as t-shirts or shorts, while showering and place it in the storage unit provided within the dirty decontamination area. Pass through the airlock into the clean decontamination area.
- c) **Clean decontamination area:** Commence showering and remove respirator. Thoroughly wash hands, fingernails, face, head and respirator. Store respirator in a suitable container within the clean decontamination area. Move to the clean change area
- d) **Clean change area:** Change into clean clothing.

### **10.2.7      *Person outside the enclosure***

The asbestos removalist should ensure a worker is stationed outside the asbestos work area, for the duration of the asbestos removal work, to:

- liaise with the project supervisor;
- communicate with personnel inside the work enclosure; and
- instigate emergency/evacuation procedures if necessary.

Records about these activities should be kept on a daily basis.

### **10.2.8      *Sealing the enclosure and decontamination unit upon the completion of the asbestos removal work***

After the removal work has been completed all plant and equipment within the asbestos work area and the decontamination unit, including any remaining non-movable items, should be vacuumed and/or wet wiped to remove any residual dust.

Once a competent person is satisfied that the asbestos work area and decontamination unit are clean, all of the cleaned surfaces should be sprayed with pigmented PVA using airless spray equipment. Items of equipment that may be damaged by the application of pigmented PVA can be screened with plastic sheeting.

Any layer of plastic forming the inner surface of the enclosed work area or decontamination unit should also be sprayed with pigmented PVA.

After the pigmented PVA has dried, a competent person should perform control monitoring in the asbestos work area and decontamination unit (see **Part 11** of this code of practice).

The final layer of any plastic enclosing the asbestos work area and decontamination unit should not be taken down until a visual inspection has found no visible asbestos residue and clearance monitoring indicates airborne asbestos fibre levels are below 0.01 fibres/mL. Settled dust sampling may also be considered as an indicator of cleanliness.

Plastic sheeting and any similar materials used for the enclosure should be treated as asbestos waste. This need not apply to scaffolding used to add strength to the enclosure, but any such scaffolding should be vacuumed, damp wiped and sprayed with pigmented PVA as part of the clean-up process.

Ropes, warning signs and protective plastic isolating public areas should not be removed until the asbestos work area and decontamination unit have had a satisfactory clearance inspection

### **10.3 Mini-enclosures for small-scale asbestos removal work**

Mini-enclosures are suitable for asbestos removal work in areas with restricted access, such as ceiling spaces, and for emergency asbestos removals.

The mini-enclosure has to be large enough to allow movement inside the enclosure and contain all the equipment needed for the asbestos removal work.

Machinery that emits exhaust fumes must not be placed in a mini-enclosure.

The frame of a mini-enclosure can be made from a variety of materials, but has to be strong enough to support the plastic sheeting that forms the enclosure.

Heavy-duty plastic sheeting (200 µm minimum thickness) should be used for making the enclosure. Recycled plastic, including re-milled plastic, must not be used.

The tape used to connect the plastic to the frame needs to be strong enough to securely hold the plastic to the frame. A smoke tube should be used to check the sealing of the plastic sheeting.

A slit will have to be made in the plastic sheeting to allow entry. This slit can then be taped from inside the enclosure.

A typical layout is shown in **Figure 2**.

The hazards and work procedures that need to be considered for large enclosures, discussed in section 10.2, also need to be taken into account for all mini-enclosures.

Workers leaving a mini-enclosure must follow the personal decontamination procedures described in section 9.9.4.

Figure 2

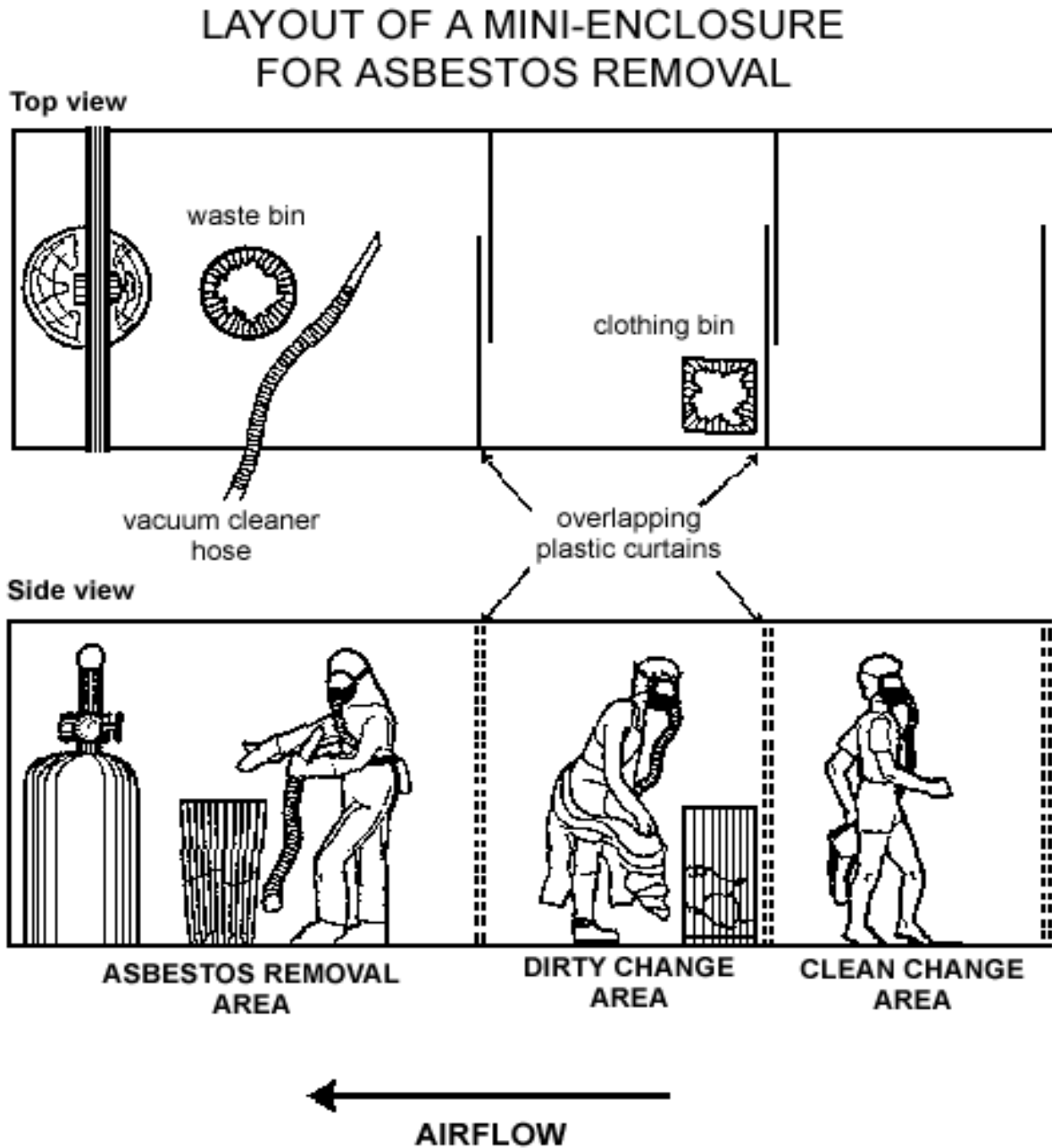

## 10.4 Glove bag removal method

Glove bags are single-use bags, constructed from transparent, heavy-duty plastic, with built-in arms and access ports.

Generally these glove bags are approximately 1 metre wide and 1.5 metres deep.

Glove bags are designed to isolate small removal jobs from the general working environment. As such, they provide a flexible, easily installed and quickly dismantled temporary enclosure for small asbestos removal jobs.

The glove bag removal method is especially suited to the removal of asbestos lagging from individual valves, joints, piping, etc.

A major advantage of glove bags is that they contain all waste and contamination within the bag, thereby eliminating the need for extensive PPE and decontamination.

The only significant limitation on the use of glove bags is the volume of waste material they are able to contain. Care needs to be exercised to prevent overfilling of the bag with water or waste.

Glove bags should be used as follows (see **Figure 3**):

- a) Cutting and removal tools that will be used in the removal should be placed into the glove bag at the start of the job. When the removal is complete, tools used should be either disposed of as asbestos waste or sealed for reuse in future removal jobs.
- b) The glove bag should completely cover the pipe or object on which the asbestos removal work is to be performed. The lagging on either side of the bag must be sound enough to support the weight of the bag and its wet contents.
- c) Cut the sides of the glove bag to fit the size of the pipe from which asbestos is to be removed. Attach the glove bag to the pipe by folding the open edges together and securely sealing them with duct tape. Seal all openings in the glove bag with duct tape or an equivalent. The bottom and side seams of the glove bag should also be sealed with duct tape or an equivalent, to prevent any leakage if there is a defect in a seam.
- d) Thoroughly saturate the ACM with a wetting agent and then remove it from the pipe, beam or other surface. The wetting agent should be applied with an airless sprayer through a pre-cut port, as provided in most glove bags, or through a small hole cut in the bag. ACM that has fallen into the bag should be thoroughly saturated. The choice of tool to remove the ACM depends on the nature of the material to be removed. ACM are generally covered with painted canvas and/or wire mesh. Any canvas should be cut and peeled away from the ACM underneath. If this ACM is dry, it should be re-sprayed with the wetting agent before it is removed.
- e) Thoroughly clean the pipe or surface from which the asbestos has been removed with a wire brush and wet-wipe it until no traces of the ACM can be seen. Wash down the upper section of the bag to remove any adhering ACM.
- f) Seal any edges of ACM that have been exposed by the removal or by any maintenance activity, to ensure these edges do not release airborne asbestos fibres after the glove bag is removed.
- g) Once the ACM has been removed and sealed, insert a vacuum hose from an asbestos vacuum cleaner into the glove bag through the access port to remove any air in the bag that might contain airborne asbestos fibres. Once the bag has been evacuated, squeeze it tightly, as close to the top as possible, twist it and seal it with tape, keeping the ACM safely in the bottom of the bag.

- h) Remove the vacuum line from the bag, and then remove the glove bag from the workplace for proper disposal as asbestos waste.

Figure 3

FIGURE 4

### USE OF GLOVE BAGS

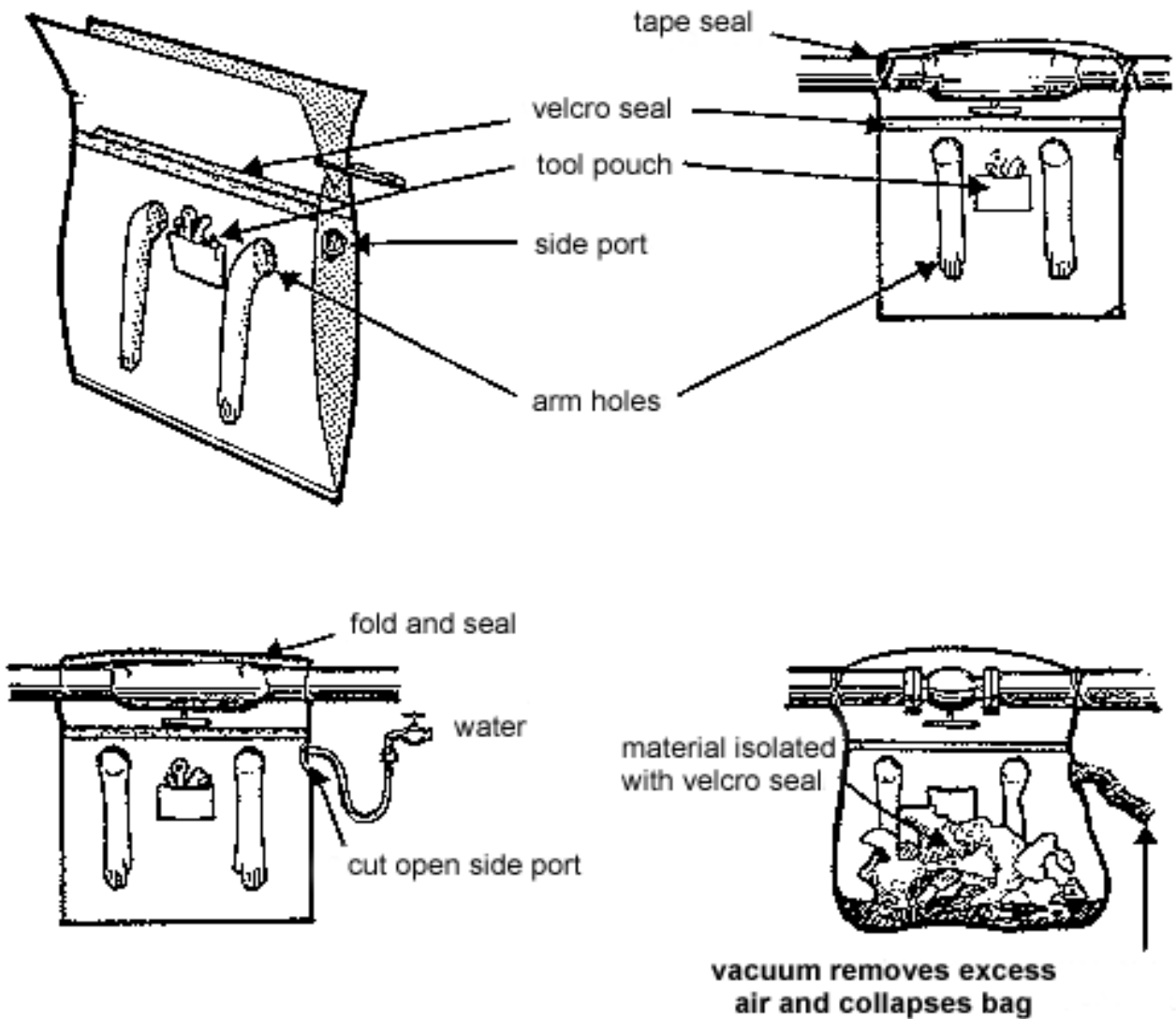

## 10.5 'Wrap and cut' removal method

This method of removal produces the lowest levels of airborne asbestos fibres and is most appropriate for redundant plant and equipment.



The plant or equipment to be removed should be double wrapped with 200 µm thick plastic and taped so that the ACM are totally sealed within the plastic. The wrapped plant or equipment can then be cut from the rest of the plant and equipment using mechanical shears or oxy-cutting tools. Only exposed metal should be cut, and care should be taken to ensure the plastic wrapping is not punctured and/or melted.

If lagging has to be removed to allow a pipe to be cut, the glove bag removal method should be used to expose the metal at the point to be cut and for a sufficient length on either side. The insulation should be wet thoroughly, bagged and disposed of as asbestos waste. The pipe should then be cut at the centre of the exposed section.

## **PART 11. CLEARANCE TO REOCCUPY AN ASBESTOS WORK AREA**

Before clearance is granted for an asbestos work area to be re-occupied there must be a thorough clearance inspection.

The clearance inspection must be conducted by competent person who is independent from the person responsible for the removal work

Following the final clearance inspection a clearance certificate must be issued by a competent person, who is independent from the person responsible for the removal work, if this is requested by the relevant State or Territory OHS authority.

Any protective barrier between the asbestos work area and public areas should remain intact until completion of all asbestos removal work and successful completion of the clearance inspection.

### **11.1 Visual inspections**

Visual inspections involve an examination of the asbestos work area, prior to the resumption of normal work in the area by unprotected personnel, to confirm that the asbestos removal work has been completed and there is no visual evidence of dust and debris.

Particular attention should be paid to ledges, the tops of air-conditioning ducts, cracks in the floor, folds in plastic sheeting and crevices or other areas which may have been overlooked during the initial clean-up.

A satisfactory visual inspection does not remove the need to perform clearance monitoring.

### **11.2 Clearance monitoring**

The need for clearance monitoring should be assessed as part of the planning and conduct of asbestos removal works.

Monitoring results and experience with similar removals in the past will assist in determining whether clearance monitoring will be required.

Clearance monitoring should be undertaken by a competent person who is independent from the person responsible for the removal work, after cleaning has been completed and the area dried, to check that fibre levels are below 0.01 fibres/mL.

Air samples should be taken in the asbestos work area. For jobs involving an enclosed area, this should be done within the enclosed area, following the completion of the removal work but prior to the removal of the enclosure, and again after the removal of the enclosure (for a final clearance inspection).

The removal work should not be considered completed until an airborne fibre level of less than 0.01 fibres/mL has been achieved, as determined by the clearance monitoring.

### 11.3 Settled dust sampling

Settled dust sampling may also be useful as part of a clearance inspection.

Settled dust sampling can, however, only provide an *indication* of cleanliness.

Settled dust sampling should not be used as an indicator of risk to health.

Any settled dust sampling should be determined by the competent person undertaking the visual inspection.

## **PART 12. EXAMPLES OF SPECIFIC ASBESTOS REMOVAL PROCEDURES**

The specific removal requirements outlined in this **Part 12** of this code of practice supplement the requirements set out elsewhere in this code of practice.

When in doubt, the relevant State or Territory OHS authority should be consulted on the control measures required.

### **12.1 Removal of asbestos-cement products**

Historically, a large number of asbestos-cement building products have been used in the building industry in Australia.

These asbestos-cement products — about 15% asbestos fibres, by weight — include, but are not limited to,

- flat or corrugated wall and roof sheeting ('fibro');
- floor sheeting;
- water, drainage and flue pipes;
- roofing shingles, and
- flexible building boards (e.g. Villaboard, Hardiflex, Wundaboard and Flexiboard).

While new fibre-cement products no longer contain asbestos, which was replaced by non-asbestos fibres such as cellulose in the late 1980s, crocidolite (blue asbestos) and amosite (brown asbestos) were extensively used in many asbestos-cement building products until the 1970s and chrysotile (white asbestos) was used almost exclusively in fibre-cement products during the 1970s and 1980s.

#### ***12.1.1 Preparation and enclosure***

Asbestos-cement products would normally be assessed as non-friable, even though they can suffer significant weathering in outdoor environments. Provided these asbestos-containing building products are maintained in good order, they present a low health risk.

Precautions should be observed, however, during structural alterations or demolitions involving these products.

Hail, storm and fire damaged asbestos-cement products can pose a high risk of asbestos exposure, and should be assessed to determine if they are friable.

Under normal removal conditions the removal of asbestos-cement products does not attract a recommendation for extraction ventilation.

The minimum suitable respiratory protection is a P1 or P2 half-face respirator with a particulate filter. Section 9.7 provides further information on the selection, use and maintenance of appropriate RPE and PPE.

The need for an enclosure and a decontamination facility should be determined by a risk assessment. The decontamination facilities should be located inside the asbestos work area.

Decontamination facilities, appropriate for the removal job, should be available throughout the entire removal process.

The relevant State or Territory OHS authority should be consulted to determine whether a licence is required for this type of asbestos removal work.

### **12.1.2 Removal**

The work area should be kept clean, tidy and free from asbestos-cement debris, with the area being cleaned up on at least a daily basis. All the debris should be collected and disposed of as asbestos waste (see sections 9.10 and 9.11).

Wherever possible, the removal of asbestos-cement should use the wet spray method, unless this might create an electrical hazard.

The dropping of asbestos-cement and the use of ramps, chutes or similar gravity-dependent devices should not be allowed under any circumstances.

#### **12.1.2.1 Removal of asbestos-cement sheets**

If the asbestos-cement is behind ceramic tiles, sufficient tiles should be removed to give access to the fixings of the asbestos-cement sheet, taking care to minimise any damage to the sheet.

Fixings holding the asbestos-cement sheet in place should be cut with a cold chisel under the edge of the sheet or cut around the head using a punch, again so as to minimise damage to the sheet. If necessary, nails should be punched through the sheeting to facilitate effective removal.

All nails and asbestos waste should be removed from the timber. The sheets should be removed with as little breakage as possible. Unnecessary breaking of asbestos-cement sheeting must not be permitted.

The asbestos-cement sheets should be wetted using a fine water spray. Once they are removed, the backs of the sheets should be wetted using a fine water spray and the sheets should be placed into a waste skip, vehicle tray or similar receptacle (see section 9.10.4). Smaller pieces of sheeting and asbestos-cement debris should be placed in heavy-duty clear plastic bags. Section 9.10 provides information on appropriate waste removal methods.

#### **12.1.2.2 Removal of asbestos-cement roofing**

Asbestos-cement roofing should be sprayed with PVA prior to the removal process. The PVA must be dry before sheet removal begins, to avoid a slip hazard.

Asbestos-cement can become brittle with age, so any removal work on roofs must address the risk of fall hazards.

The removal of asbestos-cement roofing must be performed in accordance with all relevant State or Territory legislation for working on roofs and at heights.

Angle grinders should not be used, because of the potential for damage to the asbestos-cement and subsequent fibre release. Anchoring screws/bolts should be removed from the roofing sheets using an oxy torch or another suitable device that will not significantly damage the sheet.

If lichen is encountered on roof sheeting, caution should be exercised in the use of water and the choice of workers' footwear because lichen can be slippery, especially when it is wet. In these instances, the asbestos removalist should confer with the person with control, to determine appropriate controls, before commencing the work.

Roof sheeting should be lowered to the ground using slings and/or lifting equipment such as a crane or a forklift.

### **12.1.3 Decontamination**

#### **12.1.3.1 Decontamination of the work area**

On completion of the removal, the asbestos removalist should clean up all dust and debris within the removal area, and in particular from the framework, ceiling spaces and exposed wall cavities, using the procedures outlined in section 9.9.1.

If asbestos-contaminated nails are to be reused they must be decontaminated. Nails that can not be decontaminated must be removed from the timber and disposed of as asbestos waste.

Rough-sawn timber cannot be effectively wet wiped or vacuum cleaned. If the timber is to remain *in situ* or be recycled, it should be sealed with pigmented PVA, using low-pressure spray equipment.

#### **12.1.3.2 Personal decontamination**

PPE should be vacuumed and wet wiped, in conjunction with any other decontamination methods. Decontamination should be carried out in a designated area. Contaminated PPE should not be worn outside the asbestos work area under any circumstances.

There maybe circumstances where a full decontamination unit should be used for personal decontamination. A risk assessment should be conducted to determine appropriate decontamination requirements.

## **12.2 Removal of vinyl floor tiles and sheet vinyl containing asbestos**

In the 1960s and 1970s vinyl floor tiles and vinyl floor sheets were commonly reinforced with asbestos in a bonded matrix. A visual inspection cannot determine whether vinyl floor tiles contain asbestos.

### **12.2.1      *Preparation and enclosure***

All fittings and fixtures on top of the vinyl floor should be removed before the vinyl is taken up.

If the removal includes grinding or abrading, the wet spray method should be used (see section 9.5.1) and the removal undertaken within an enclosure. **Part 10** of this code of practice provides information on the use of enclosures.

The minimum respiratory protection for this operation is a P1 or P2 filter with a half-face piece respirator. If grinding or abrading is involved, the minimum recommended respiratory protection is a P3 full-face, particulate, filter (cartridge) respirator. Section 9.7 provides further information on the selection, use and maintenance of appropriate RPE and PPE.

Decontamination facilities should be available throughout the entire removal process. A decontamination unit, as described in section 10.2.3, should be available when grinding or abrading is undertaken and otherwise as determined by a risk assessment. Section 10.2.4 provides information for situations where the decontamination unit cannot be located immediately adjacent to the asbestos work area.

### **12.2.2      *Removal***

Wherever possible, removal methods such as scraping, chipping or the use of a wide bladed tool should be used. Grinding and abrading should only be used if there is no other suitable alternative. Care should be taken to minimise dust release from the activity. Where grinding or abrading is used, and the asbestos work area is not enclosed, the equipment should be fitted with or connected to an asbestos vacuum cleaner.

The vinyl can be cut into strips prior to its removal, to facilitate bagging, or it can be rolled into one roll and wrapped securely with plastic, making sure it is totally sealed.

If a heat source is used to soften the adhesive beneath a vinyl tile, care should be taken not to scorch or burn the tile. Burning or scorching vinyl tiles can result in the release of toxic decomposition products and generate a fire hazard. In some cases the adhesive may contain asbestos.

## **12.3      *Removal of asbestos-backed vinyl and millboard from beneath a vinyl floor***

### **12.3.1      *Preparation and enclosure***

All fittings and fixtures on top of the floor vinyl should be removed before the vinyl is taken up.

The minimum respiratory protection for this operation is a P3 full-face powered air-purifying particulate respirator. Section 9.7 provides further information on the selection, use and maintenance of appropriate RPE and PPE.

Since asbestos millboard is typically 100% asbestos and very friable, a full enclosure, with negative air extraction units, must be used for this type of removal. **Part 10** of this code of practice provides information on the use of enclosures for the removal of friable ACM.

A decontamination unit must be available at all times (see section 10.2.3).

### **12.3.2 Removal**

The asbestos millboard should be wetted down as the vinyl is peeled from the floor, preferably with the millboard attached.

The vinyl can be cut into strips prior to its removal, to facilitate bagging, or it can be rolled into one roll and wrapped securely with plastic, making sure it is totally sealed.

If the vinyl sheeting cannot be removed without leaving some of the asbestos millboard on the floor surface, the remaining asbestos millboard should be wetted down and, when thoroughly soaked, scraped off the floor surface.

Sufficient water should be used to dampen the asbestos millboard, but not so much that run-off or pools of contaminated water will occur.

If a heat source is used to soften the adhesive beneath a vinyl tile, care should be taken not to scorch or burn the tile. Burning or scorching vinyl tiles can result in the release of toxic decomposition products and generate a fire hazard.

Alternative removal methods should only be used if they do not result in excessive fibre release from the asbestos millboard and do not result in any additional hazard.

## **12.4 Removal of asbestos gaskets and rope from plant and equipment**

Gaskets reinforced with asbestos were once used extensively in plant and equipment exposed to high temperatures and/or pressures. These gaskets were typically used between the flanges of pipes.

Asbestos rope was often used for lagging pipes and valves and for sealing hatches.

It is likely that the ACM in gaskets and rope from plant and equipment will be friable.

### **12.4.1 Preparation**

Ensure the plant or equipment is shut down and isolated.

The minimum respiratory protection suitable for this operation is a P1 or P2 filter with a half-face piece respirator.

### **12.4.2 Removal**

Dismantle the equipment carefully. Protect any other components with plastic sheeting.



Thoroughly dampen the gasket or rope with water. Use a hand scraper to slowly remove the gasket or rope. Continue to dampen as drier material is exposed.

Collect the removed ACM in a container directly beneath the scraper.

All of the asbestos gasket or rope should be removed.

## **12.5 Removal of asbestos switchboards or meter boards**

Historically, ACM were used in and around switchboards and meter boards to provide electrical insulation and to prevent fire spreading from the boards.

ACM were used in the front panels and also in materials that covered the inside and back of the switchboard boxes. Small electrical load centres (with a main switch plus a few fuses) have also been known to have ACM backings.

A competent person must isolate the relevant switchboard or meter board before any work occurs.

When removing an asbestos switchboard or meter board any other ACM, such as fire proofing on the switchboard box sides and base, should also be removed.

### ***12.5.1 Preparation***

Electricity must be disconnected from the switchboard or meter panel by a licensed electrician. Once this is tested and confirmed the removal process can begin.

All wiring at the back of the switchboard or meter board should be disconnected or isolated by a competent person. If this is not practical, the wiring should be suitably terminated and labelled to indicate that it is live, and the wiring should be protected against mechanical damage or otherwise rendered safe. The switchboard or meter panel and surrounding area should be cleaned before removal work is started.

The minimum suitable respiratory protection is a P1 or P2 half-face respirator with a particulate filter. Section 9.7 provides further information on the selection, use and maintenance of appropriate RPE and PPE.

### ***12.5.2 Removal***

Lay out a 200 µm thick plastic sheet to catch any debris that may fall.

Remove the mounting screws from the board without damaging the board. Vacuum the front surface of the board using an asbestos vacuum cleaner. Tilt the board forward and disconnect the cabling from the board. Wrap the board in a double layer of heavy duty, 200µm thick plastic sheeting (see sections 9.10 and 9.11 on waste removal).

### ***12.5.3 Decontamination***

Vacuum the area where the board was located and the surrounding area. Wet wipe with a rag to remove minor amounts of debris that may be attached to the wall or cabling. Dispose

of this rag as asbestos waste. Vacuum the sheet of plastic laid out to catch any debris and dispose of it as asbestos waste.

## **12.6 Removal of asbestos mastics and bitumen**

Mastics and bitumen are usually soft, so they were often reinforced with asbestos to give them strength while retaining their flexibility.

### ***12.6.1 Preparation***

The minimum respiratory protection suitable for this operation is a P1 or P2 filter with a half-face piece respirator. Section 9.7 provides further information on the selection, use and maintenance of appropriate RPE and PPE.

### ***12.6.2 Removal***

Because these ACM are flexible they need to be removed using scraping and chipping tools. The pieces removed should be kept as intact as possible.

If heating is used to soften the material, to enable the material to be peeled, it is important not to burn the material, as this can release airborne asbestos fibres. Excessive heating is also likely to generate toxic fumes and gases and generate a fire hazard.

## **12.7 Removal and cleaning of ceiling tiles**

False ceiling tiles or suspended ceilings sometimes need to be removed so maintenance work can be performed.

If ACM have been used on structural materials above a false ceiling there could be contamination on the upper surface of the tiles.

### ***12.7.1 Preparation***

The minimum respiratory protection suitable for this operation is a P1 or P2 filter with a half-face piece respirator. If considerable amounts of asbestos dust or debris are likely to be involved, full-face air-purifying positive pressure respirators should be worn. Section 9.7 provides further information on the selection, use and maintenance of appropriate RPE and PPE.

### ***12.7.2 Method***

Any surface below the tiles that might be contaminated should be covered with plastic sheeting.

The first tile should be lifted carefully to minimise the disturbance of any asbestos fibres. The top of each tile should be thoroughly vacuumed and wet wiped, where possible, prior to removing subsequent tiles.

Where non-asbestos ceiling tiles are to be reused, they should be covered with plastic as they are removed from the ceiling, to prevent further dust settling on them.

Asbestos-ceiling tiles must not be reused. Under the asbestos prohibition it is illegal to reuse and reinstall asbestos products. Wrap the asbestos-ceiling tiles in a double layer of heavy duty, 200µm thick plastic sheeting (see sections 9.10 and 9.11 on waste removal).

Ceiling tiles should not be placed in the ceiling until the areas of the ceiling space affected by the maintenance work have been cleaned.

## **12.8 Removal of asbestos friction products**

### ***12.8.1 Preparation and enclosure***

Asbestos friction products can be removed outside an enclosure using a low-pressure wet spray method. Asbestos vacuum cleaners should be used for the dry removal method.

The removal of asbestos friction products should be performed in an area that is not affected by wind.

The minimum respiratory protection suitable for this operation is a P1 or P2 respirator. Section 9.7 provides further information on the selection, use and maintenance of appropriate RPE and PPE.

### ***12.8.2 Removal***

The preferred method for removal is using a combination of vacuuming and the wet method. Either method can be used in isolation, however, providing all precautions are taken.

Compressed air must not be used to remove dust or debris from wheels or other parts of a vehicle.

Power tools should not be used. Hand tools should be used, to reduce the risk of airborne fibres.

#### ***12.8.2.1 Wet method:***

Use a suitable collection device (i.e. tray or container) below the location where the work will be carried out, to collect any dust or run-off. Wet the wheel and brake area with a fine water spray. Wipe down the wheel or automobile part using the wet method before removal.

A misting spray bottle should be used to wet down any dust. If the use of spray equipment to wet the asbestos is likely to disturb asbestos fibres, alternative wetting agents, such as a water-miscible degreaser or a water and detergent mixture, should be used.

Partially open the housing and softly spray the inside with water using the misting spray bottle. Any spillage of dust, debris or water must be controlled (e.g. through the use of containers to capture runoff) and either filtered or disposed of as asbestos waste.

Fully open the housing and remove the component.

### 12.8.2.2 *Dry method:*

A collection tray should be placed under the components to capture any dust spilling from the brake drum etc during removal.

Use an asbestos vacuum cleaner to remove asbestos fibres from the brakes and rims or other ACM.

## **APPENDIXES**



## APPENDIX A. EXAMPLES OF ASBESTOS-CONTAINING MATERIALS

(This is not an exhaustive list)

### A

Air-conditioning ducts: exterior or interior acoustic and thermal insulation	Asbestos-cement sheet internal walls and ceilings
Arc shields in lift motor rooms or large electrical cabinets	Asbestos-cement sheet underlays for vinyl
Asbestos-based plastics products - as electrical insulates and acid-resistant compositions or aircraft seat	Asbestos-cement storm drain pipes
Asbestos ceiling tiles	Asbestos-cement water pipes (usually underground)
Asbestos-cement conduit	Asbestos-containing laminates (e.g. formica) used where heat resistance is required, e.g. ships
Asbestos-cement electrical fuse boards	Asbestos-containing pegboard
Asbestos-cement external roofs and walls	Asbestos felts
Asbestos-cement in the use of form work when pouring concrete	Asbestos marine board, e.g. marinate
Asbestos-cement internal flues and downpipes	Asbestos mattresses used for covering hot equipment in power stations
Asbestos-cement moulded products such as gutters, ridge cappings, gas meter covers, cable troughs and covers	Asbestos paper used variously for insulation, filtering and production of fire resistant laminates
Asbestos-cement pieces for packing spaces between floor joists and piers	Asbestos roof tiles
Asbestos-cement (underground) pits, as used for traffic control wiring, telecommunications cabling, etc	Asbestos textiles
Asbestos-cement render, plaster, mortar and coursework	Asbestos textile gussets in air-conditioning ducting systems
Asbestos-cement sheet	Asbestos yarn
Asbestos-cement sheet behind ceramic tiles	Autoclave / steriliser insulation
Asbestos-cement sheet internal over exhaust canopies such as ovens, fume cupboards, etc.	

### B

Bitumen-based water proofing such as malthoid, typically on roofs and floors but also in brickwork

Bituminous adhesives and sealants

Boiler gaskets

Boiler insulation, slabs and wet mix

Brake disc pads

Brake linings

## C

Cable penetration insulation bags (typically Telecom)

Calorifier insulation

Car body filters (not common)

Caulking compounds, sealant and adhesives

Cement render

Chrysotile wicks in kerosene heaters

Clutch faces

Compressed asbestos-cement panels for flooring, typically verandas, bathrooms and steps for demountable buildings

Compressed asbestos fibres (CAF) used in brakes and gaskets for plant and automobiles

## D

Door seals on ovens

## E

Electric heat banks - block insulation

Electric hot water services - normally not asbestos but some millboard could be present

Electric light fittings, high wattage, insulation around fitting (and bituminised)

Electrical switchboards – see Pitch-based

Exhausts on vehicles

## F

Filler in acetylene gas cylinders

Filters - beverage; wine filtration

Fire blankets

Fire curtains

Fire door insulation

Fire-rated wall rendering containing asbestos with mortar

Fire-resistant plaster board, typically on ships

Fire-retardant material on steel work supporting reactors on columns in refineries in the chemical industry

Flexible hoses

Floor vinyl sheets

Floor vinyl tiles

Fuse blankets and ceramic fuses in switchboards

## G

Galbestos™ roofing materials (decorative coating on metal roof for sound proofing)

Gaskets - chemicals, refineries

Gaskets - general

Gauze mats in laboratories / chemical refineries

Gloves - asbestos

## H

Hairdryers - insulation around heating elements

Header (manifold) insulation

## I

Insulation blocks

Insulation in electric reheat units for air-conditioner systems



## **L**

Laboratory bench tops

Laboratory fume cupboard panels

Laboratory ovens - wall insulation

Lagged exhaust pipes on emergency power generators

Lagging in penetrations in fireproof walls

Lifts shafts - asbestos-cement panels lining the shaft at the opening of each floor, and asbestos packing around penetrations

Limpet asbestos spray insulation

Locomotives - steam; lagging on boilers, steam lines, steam dome and gaskets

## **M**

Mastics

Millboard between heating unit and wall

Millboard lining of switchboxes

Mortar

## **P**

Packing materials for gauges, valves, etc., can be square packing, rope or loose fibre

Packing material on window anchorage points in high rise buildings

Paint, typically industrial epoxy paints

Penetrations through concrete slabs in high rise buildings

Pipe insulation including moulded sections, water-mix type, rope braid and sheet

Pitch-based (e.g. zelemite, ausbestos, lebah) electrical switchboard

Plaster and plaster cornice adhesives

## **R**

Refractory linings

Refractory tiles

Rubber articles - extent of usage unknown

## **S**

Sealant between floor slab and wall, usually in boiler rooms, risers or lift shafts

Sealant or mastik on windows

Sealants and mastics in air-conditioning ducting joints

Spackle or plasterboard wall jointing compounds

Sprayed insulation - acoustic wall and ceiling

Sprayed insulation - beams and ceiling slabs

Sprayed insulation - fire retardant sprayed on nut internally, for bolts holding external building wall panels

Stoves - old domestic type; wall insulation

## **T**

Tape and rope - lagging and jointing

Tapered ends of pipe lagging, where lagging is not necessarily asbestos

Tilux sheeting in place of ceramic tiles in bathrooms

Trailing cable under lift cabins

Trains - country - guards vans - millboard between heater and wall

Trains - Harris cars - sprayed asbestos between steel shell and laminex

## **V**

Valve, pump, etc. insulation

**W**

Welding rods

Woven asbestos cable sheath

## APPENDIX B. EXAMPLES OF ASBESTOS WARNING LABELS AND SIGNS

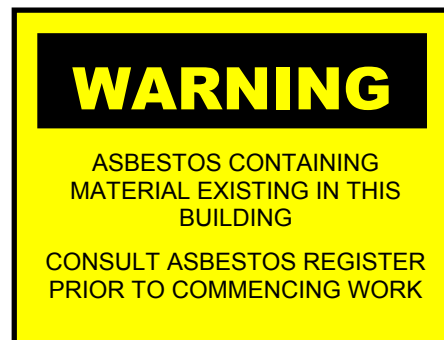
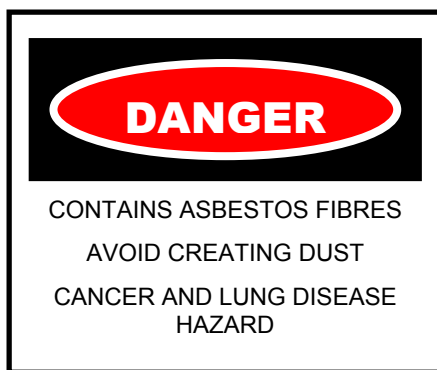
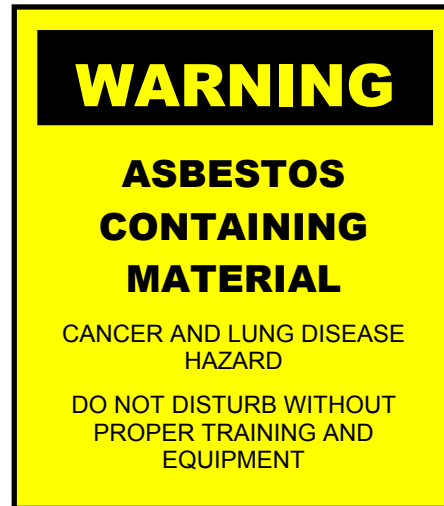
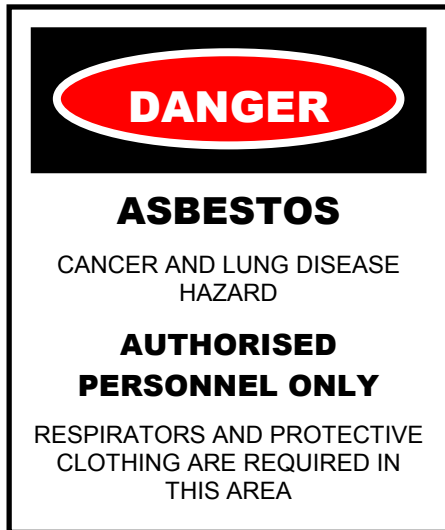



## APPENDIX C.      **GUIDE TO THE SELECTION OF RESPIRATORY PROTECTION**

There is a wide range of respiratory protection available for protection against airborne asbestos fibres.

In general, the selection of suitable respiratory protection equipment depends on the nature of the asbestos work, the probable maximum concentrations of asbestos fibres that would be encountered in this work and any personal characteristics of the wearer that may affect the facial fit of the respirator (e.g. facial hair and glasses).

**Table 3** below provides, in approximate order of increasing efficiency, an overview of some of the respirators which can be used for protection against airborne asbestos fibres. The protection afforded by each device depends not only on the design and fit of the respirator but also upon the efficiency of the filters (i.e. P1, P2 or P3).

Australian Standards AS1715 and AS1716 provide detailed advice on the selection, use and maintenance of respiratory protection equipment and should be consulted for more detailed advice on 'Nominal Protection Factors' and other relevant matters.

**Table 3 – Respirators**

FIGURE	RESPIRATOR
1	Disposable, half-face particulate respirator
2	Half-face, particulate filter (cartridge) respirator
3	Powered, air-purifying, ventilated helmet respirator
4	Full-face, particulate, filter (cartridge) respirator
5a	Full-face, powered air-purifying particulate respirator – Face Piece
5b	Full-face, powered air-purifying particulate respirator – Power pack
6	Full-face, positive pressure demand air-line respirator
7	Full suit or hood, continuous flow air-line respirator

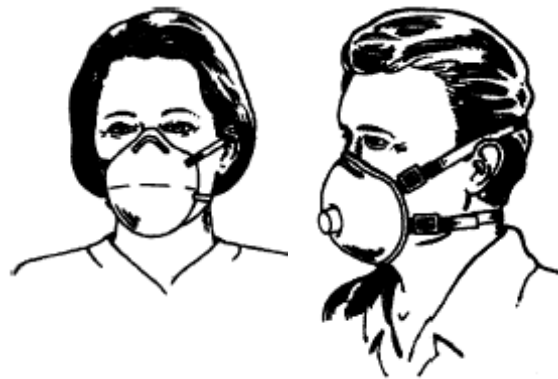

Figure 1



Figure 2



Figure 3



Figure 4

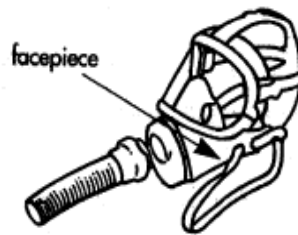

Figure 5a

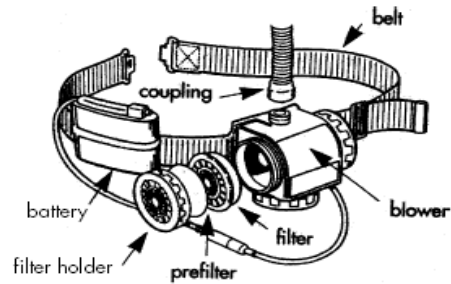

Figure 5b



Figure 6

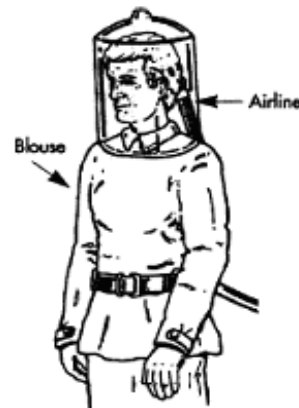

Figure 7

**Note:** These diagrams are indicative only. In order to show the correct respirator fit they do not show the use of hoods. Respirators must always be worn under a hood.

**Table 4** below provides guidance for the selection of appropriate respiratory protection for different tasks, assuming the correct work procedures are being followed.

This guide does not take account of personal features such as facial hair or the need to wear spectacles (full protection will not be achieved if either of these factors interferes with the face seal). It also does not take any account of misuse of the protective equipment.

The respirators and filters presented in **Table 4** are the minimal recommended for the corresponding task. The most efficient respirator and filter should be used.

**Table 4 – Selection of appropriate respiratory equipment**

Work procedure	Required respirator	Filter type (where applicable)
Simple enclosure erection for containing undamaged asbestos materials to prevent damage – no direct handling but possible disturbance of asbestos	Disposable, half-face particulate respirators or Half-face, particulate filter (cartridge) respirator	P1 or P2
Inspection of the condition of any installed, friable asbestos, which appears in poor condition or has been disturbed	Disposable, half-face particulate respirators or Half-face, particulate filter (cartridge) respirator	P1 or P2
Sampling material for the purpose of identifying asbestos	Disposable, half-face particulate respirators or Half-face, particulate filter (cartridge) respirator	P1 or P2
For work with asbestos-cement (fibro) (e.g. hand drilling and sawing)*.	Disposable, half-face particulate respirators or Half-face, particulate filter (cartridge) respirator	P1 or P2
For work with asbestos based friction materials*	Disposable, half-face particulate respirators or Half-face, particulate filter (cartridge) respirator	P1 or P2
Removal of non-friable asbestos (e.g. asbestos-cement and ceiling tiles)	Disposable, half-face particulate respirators or Half-face, particulate filter (cartridge) respirator	P1 or P2
Maintenance work in the vicinity of installed asbestos insulation – no direct handling but possible disturbance of asbestos	Full-face, particulate, filter (cartridge) respirator	P3

Work procedure	Required respirator	Filter type (where applicable)
Extensive sample operations on friable asbestos	Full-face, particulate, filter (cartridge) respirator or Full-face, positive pressure demand air-line respirator or Full suit or hood, continuous flow air-line respirator	P3
Maintenance work involving the removal of small quantities of friable asbestos (e.g. replacement of asbestos gaskets and insulation)	Full-face, particulate, filter (cartridge) respirator or Full-face, positive pressure demand air-line respirator or Full suit or hood, continuous flow air-line respirator	P3
Certain forms of wet stripping in which wetting is prolonged and effective, and certain small-scale dry stripping operations.	Full-face, powered air- purifying particulate respirator or Full-face, positive pressure demand air-line respirator.	P3
Certain forms of dry stripping (e.g. asbestos vinyl floor tiles, bituminous products containing asbestos [i.e. malthoid]); ineffective wet stripping (light wetting, no time given to saturate)	Powered air- purifying particulate respirator or Full-face, positive pressure demand air-line respirator. NO LESSER RESPIRATOR WILL SUFFICE.	P3
Dry stripping in confined areas	Full suit or hood, positive pressure demand continuous flow air-line respirator. NO LESSER RESPIRATOR WILL SUFFICE.	P3

**\* Note:** *High dust producing processes must be avoided by keeping materials damp and by using non-powered tools or tools equipped with exhaust ventilation.*



## APPENDIX D. REFERENCES

All NOHSC publications are free and are available from the NOHSC Website at <http://www.nohsc.gov.au>.

National Exposure Standards for hazardous substances can be found utilising the NOHSC Hazardous Substances Information System (HSIS) at <http://www.nohsc.gov.au/applications/hsis/>

The following documents provide additional information on asbestos removal.

1. Health and Safety Executive (HSE) (1999), *Controlled Asbestos Stripping Techniques; For Work Requiring a Licence*, Her Majesty's Stationery Office, Norwich, England
2. Health and Safety Executive (HSE) (1999), *Selection of Suitable Repertory Protective Equipment; for Work with Asbestos*, Her Majesty's Stationery Office, Norwich, England
3. Health and Safety Executive (HSE) (1999), *Working with Asbestos Cement (2<sup>nd</sup> Edition)*, Her Majesty's Stationery Office, Norwich, England
4. Health and Safety Executive (HSE) (1999), *Working with Asbestos in Buildings*, Her Majesty's Stationery Office, Norwich, England
5. Health and Safety Executive (HSE) (2001), *Asbestos Essentials Task Manual: Task Guidance Sheets for the Building Maintenance and Allied Trades*, Her Majesty's Stationery Office, Norwich, England
6. Health and Safety Executive (HSE) (2001), *Introduction to Asbestos Essentials; Comprehensive Guidance on Working with Asbestos in the Building Maintenance and Allied Trades*, Her Majesty's Stationery Office, Norwich, England
7. Health and Safety Executive (HSE) (2002), *A Comprehensive Guide to Managing Asbestos in Premises*, Her Majesty's Stationery Office, Norwich, England
8. Health and Safety Executive (HSE) (2002), *Work with Asbestos Insulation, Asbestos Coating and Asbestos Insulation Board (4<sup>th</sup> Edition)*, Her Majesty's Stationery Office, Norwich, England
9. Health and Safety Executive (HSE) (2002), *Work with Asbestos which does not normally require a licence (4<sup>th</sup> edition)*, Her Majesty's Stationery Office, Norwich, England
10. National Occupational Health and Safety Commission (NOHSC) (2005), *Code of Practice for the Management and Control of Asbestos in Workplaces* [NOHSC:2018(2005)], NOHSC, Canberra, Australia
11. National Occupational Health and Safety Commission (NOHSC) (2005), *Guidance Note on the Membrane Filter Method for Estimating Airborne Asbestos Fibres* [NOHSC:3003(2005)], NOHSC, Canberra, Australia
12. National Occupational Health and Safety Commission (NOHSC) (1994) *National Model Regulations for the Control of Workplace Hazardous Substances* [NOHSC:1005(1994)], NOHSC Canberra, Australia

13. National Occupational Health and Safety Commission (NOHSC) (1994) *National Code of Practice for the Control of Workplace Hazardous Substances* [NOHSC:2007(1994)], NOHSC Canberra, Australia
14. National Occupational Health and Safety Commission (NOHSC) (1995) *Guidelines for Health Surveillance* [NOHSC:7039(1995)], NOHSC Canberra, Australia
15. Victorian Asbestos Removal Industry Consultative Committee (VARICC), *Standard Specification for Asbestos Removal from Buildings, Structures, Ships, Plants and workplaces*, Australia

## **APPENDIX E. AUSTRALIAN STANDARDS**

The following standards are referred to in this code of practice.

1. Australian Standard 1319-1994 *Safety Signs for the Occupational Environment*
2. Australian Standard 1668.2-2002 *The Use of Ventilation and Airconditioning in Buildings – Ventilation Design for Indoor Air Contaminant Control*
3. Australia/New Zealand Standard 1715-1994 *Selection, Use and Maintenance of Respiratory Protective Devices*
4. Australia/New Zealand Standard 1716-2003 *Respiratory Protective Devices*
5. Australia/New Zealand Standard 3012-2003 *Electrical Installations – Construction and Demolition Sites*
6. Australian Standard 3544-1988 *Industrial Vacuum Cleaners for Particulates Hazardous to Health*
7. Australian Standard 4260-1997 *High Efficiency Particulate Air (HEPA) Filters – Classification, Construction and Performance*
8. Australian Standard 60529-2004 *Degrees of protection provided by enclosures (IP code)*