

Australian Capital Territory

Planning (Housing) Design Guide 2024

Notifiable instrument NI2024–512

made under the

Planning Act 2023, s 50 (Design guides)

1 Name of instrument

This instrument is the *Planning (Housing) Design Guide 2024*.

2 Commencement

This instrument commences on 27 September 2024.

3 Design guide

I make the design guide at schedule 1.

4 Revocation

This instrument revokes the *Planning (Housing) Design Guide 2023* (NI2023-542).

Chris Steel MLA
Minister for Planning
9 September 2024



ACT
Government

ACT Housing Design Guide

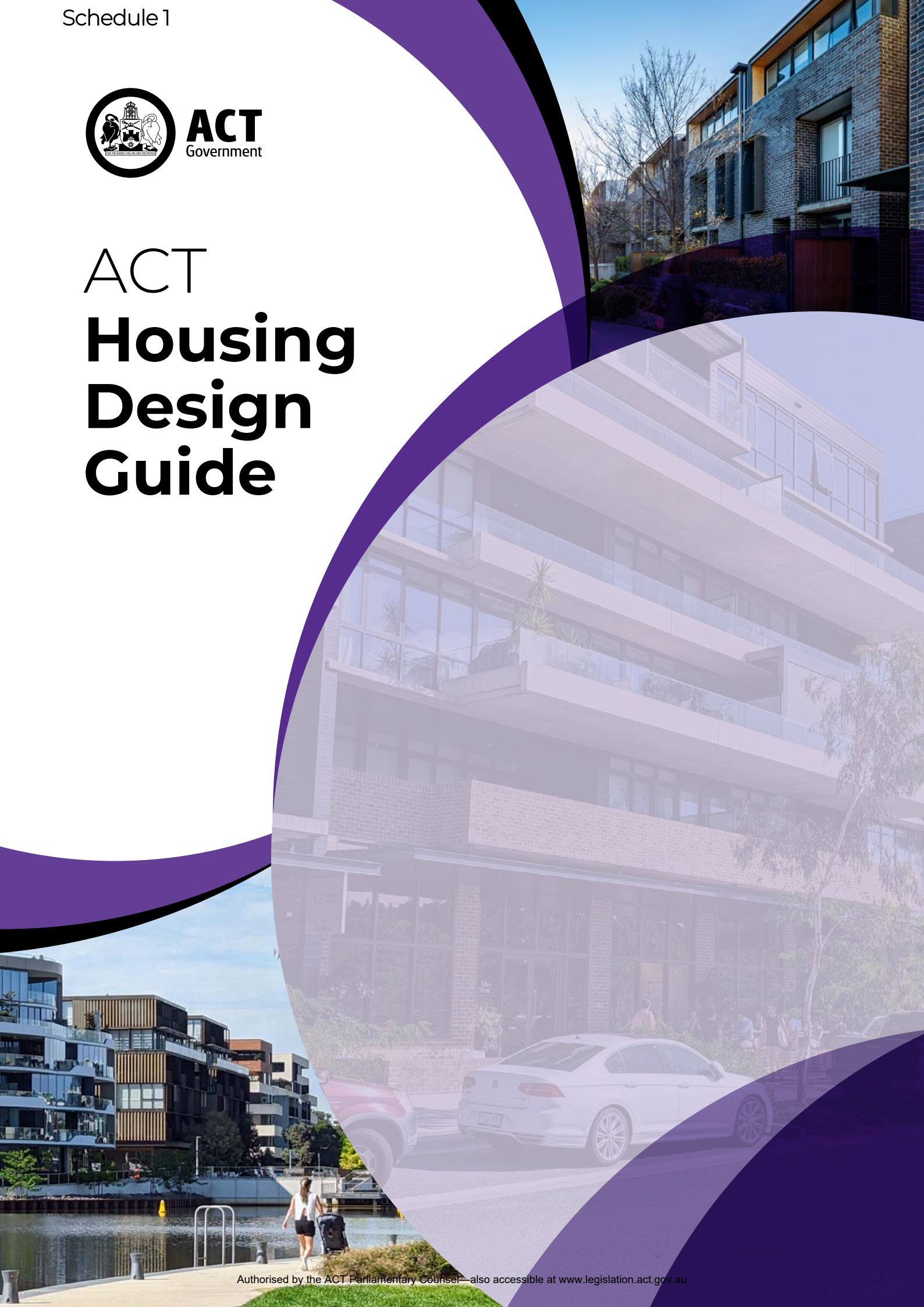



Acknowledgement of Country

Yuma

Dhawura Nguna Dhawura Ngunnawal

*Yanggu ngalawiri dhunimanyin Ngunnawalwari
dhawurawari*

Nginggada Dindi yindumaralidjinyin

Dhawura Ngunnawal yindumaralidjinyin

Hello,

This is Ngunnawal Country

Today we are meeting on Ngunnawal country

We always respect Elders, male and female

We always respect Ngunnawal Country

The ACT Government acknowledges the Ngunnawal people as traditional custodians of the ACT and recognises any other people or families with connection to the lands of the ACT and region. We acknowledge and respect their continuing culture and the contribution they make to the life of this city and this region.

Australian Capital Territory, Canberra 2023.

This work is copyright. Apart from any use as permitted under the Copyright Act 1968, no part may be reproduced by any process without written permission from:

Director-General, Environment, Planning and Sustainable Development Directorate, ACT Government, GPO Box 158, Canberra ACT 2601.

Telephone: 02 6207 1923

Website: www.planning.act.gov.au

Produced by the Environment, Planning and Sustainable Development Directorate

Accessibility

The ACT Government is committed to making its information, services, events and venues as accessible as possible.

If you have difficulty reading a standard printed document and would like to receive this publication in an alternative format, such as large print, please phone Access Canberra on 13 22 81 or email the Environment, Planning and Sustainable Development Directorate at EPSDDComms@act.gov.au

If English is not your first language and you require a translating and interpreting service, please phone 13 14 50.

If you are deaf, or have a speech or hearing impairment, and need the teletypewriter service, please phone 13 36 77 and ask for Access Canberra on 13 22 81.

For speak and listen users, please phone 1300 555 727 and ask for Canberra Connect on 13 22 81.

For more information on these services visit <http://www.relayservice.com.au>

Disclaimer: The projects and images contained within this document are not endorsed by the ACT Government and are included only for the purpose to illustrate design intent and context.

CONTENTS

HOUSING DESIGN GUIDE

PART ONE: INTRODUCTION	1		
Introduction and purpose	2	Access and Movement	40
Why the need for design guides	2	4.1 Site access and connectivity	40
Aim of the design guidelines	3	4.2 Parking and services	40
Place-based design thinking	4	4.3 Engaging with the street	40
What is place based design?	4	4.4 Active travel	40
Why is public space important?	4	Public Space and Amenity	42
National Capital Design Review Panel	4	5.1 Communal open space	42
ACT Planning process	6	5.2 Private open space	42
How these design guides relate to the Territory Plan	6	5.3 Quality public space	42
Development application process	7	5.4 Diverse users and amenities	42
How to use these guides	8	Built Form and Building Design	44
Who is this design guide for?	8	6.1 Communal open space	46
How is the design guide structured?	8	6.2 Common circulation	48
What does the design guide apply to?	8	6.3 Diverse housing choices	50
What typologies does this design guide apply to?	8	6.4 Private open space	54
Territory Plan assessment Outcomes	10	6.5 Storage	56
		6.6 Design performance	58
		Sustainability and Environment	64
PART TWO: DESIGN GUIDES	15	7.1 Climate change resilience	66
Country and Place	16	7.2 Resource capture and management	68
1.1 Ngunnawal cultural resonance	18	7.3 Integrated landscape planting	70
Urban Structure and Natural Systems	20	7.4 Flexible, robust and future proofed	72
2.1 Open space network	20	7.5 Social resilience	74
2.2 Natural systems	20	7.6 Governance models and processes	76
Site and Land Use	22	PART THREE: APPENDICES	79
3.1 Siting	24	Housing design checklist	80
3.2 Built form	28	Document references	88
3.3 Street interface	32	Glossary	90
3.4 Privately owned public spaces (POPS)	38		

Vision for Canberra

To be a sustainable, competitive and equitable city that respects Canberra's unique legacy as a city in the landscape and the National Capital, while being responsive to the future and resilient to change.



Haig Townhouses, Turner ACT. Architect: DNA Architects

A modern building with a facade of horizontal wood slats and brickwork. A large window reflects the sky and trees. The building is partially obscured by a large white circle with purple borders. The sky is clear and blue.

Part One: Introduction

INTRODUCTION AND PURPOSE

The ACT population is growing. With more people living and working in the ACT, a clear and easy to use planning system is required so we can accommodate future growth without compromising the valued characteristics of the city. Through the ACT Planning System Review and Reform Project, a new planning system has been developed that will promote better outcomes for development, the environment and, most importantly, Canberrans.

A modern planning system is fundamental to the city's vision of a liveable and sustainable city. The new system focuses on delivering high-quality built outcomes for the residents of Canberra, with embedded flexibility to encourage innovation.

The long-term goals for Canberra have changed in the 15 years since the last significant review of the Territory Plan. These changes reflect the significance of coping with climate change, providing critical infrastructure for our expanding population, and increasing housing choice and accessibility. A new Planning Act, a new Territory Plan and the addition of a new level of planning known as district strategies are among the key reforms to the planning system.

The new planning system introduces design guides to help the interpretation and application of the Territory Plan's assessment outcomes. These assessment outcomes specify ways that the desired policy outcomes for districts and zones in the ACT can be met. The design guides demonstrate ways the assessment outcomes can be met, particularly through the use of simple and clear diagrams and images.

Please refer to separate practice note which provides explanatory information on the workflow and interaction of the design guides with other design guides, specifications and the like set by other Directorates in ACT Government.

The design guides provide general best practice design guidance. Reference guides, frameworks, strategies and the like in this design guide are not exhaustive and the user should take care to consider what other documents may be required to support the design and delivery of a development for specific design matters.

WHY THE NEED FOR DESIGN GUIDES

Though the Territory Plan contains assessment outcomes that will deliver the desired planning outcomes for the ACT, these need to be supported by clear methods and examples for how they can be met. This guidance can identify matters that must be addressed and where flexibility in design can be considered.

The design guides and design evaluation processes will support the development application and assessment processes by identifying design possibilities and encouraging innovation.

They will support the Territory Planning Authority in assessing and determining development proposals that contribute to high-quality development outcomes.

The purpose of the design guides is to elevate design understanding and literacy and elevate good design outcomes by not providing prescriptive quantitative measurements, but by providing clear and easy to understand qualitative guidance that will improve built outcomes for the city.

Design guidance has been developed in consideration of a number of ACT Government strategies and policies. Please refer to the Document Reference list in this guide. In the course of developing this guide, a literature review was undertaken and relevant policies and documents were identified and are cross referenced throughout the design guide. Earlier review work engaged by EPSDD also provided a clear baseline for what constitutes good design.

Tip: These design guides, by their nature, use planning language. See the definitions in the glossary in the appendices.

AIM OF THE DESIGN GUIDELINES

The design guides will help proponents interpret and apply the Territory Plan's assessment outcomes. The design guides and design evaluation processes will also be critical in supporting the design and assessment processes, particularly those planning provisions that are less prescriptive and leave more room for interpretation and innovation.

The overall purpose of the design guides are outlined below.

- i. Urban Design Guide (UDG) addresses public space, streetscape and built form interface outcomes at a range of scales.
- ii. Housing Design Guide (HDG) addresses housing and built form outcomes at a range of densities, excluding single residential dwelling.
- iii. Biodiversity Sensitive Urban Design Guide (BSUD) provides guidance on biodiversity and ecological design matters.

Other guides as notified by the Minister pursuant to Section 50 of the Planning Act may also be included. The reasoning for the design guides which support the new Territory Plan are outlined below.

Community benefit and value

Guiding best practice design can lead to social, environmental and economic benefits to the community, government and private business. Social benefits include supporting people's quality of life and overall health and wellbeing. Environmental benefits encompass the protection and enhancement of environmental assets and the inclusion of sustainable design features and travel. Economic benefits include reduced infrastructure and delivery costs as a result of efficient land use patterns through greater density near activity centres, employment areas and active travel.

Greater clarity and flexibility in process

These guides can provide greater clarity, flexibility and consistency for the community, authority officers and industry. In supporting the new Territory Plan, they help people interpret statutory policy, and guide proponents and statutory officers (including development assessment staff, courts and tribunals) within an outcomes-based planning system paradigm; clear writing is supported by images and graphics. These guides will give all stakeholders the confidence to fully participate in the planning and development process.

Responsive to contemporary challenges

Our urban environments need to be responsive and adaptable to societal challenges such as natural hazards and pandemics. These guides can help public space and housing designs consider and be responsive to these challenges. By encouraging development to be designed in a responsive manner and of a high-quality, the guides will contribute to improvements in community health and wellbeing.

High-quality and place-based outcomes

An outcomes focused system puts the focus on achieving high quality design outcomes. These design guides support the new Territory Plan to ensure the planning system adequately considers design quality and development appropriateness, leading to improved design quality and overall planning and design outcomes. These outcomes can enable more distinctive places that have strong community identities.

PLACE-BASED DESIGN THINKING

Canberra is made up of many different places and districts, each with its own combination of people, culture, built form, landscaping and natural features. The distinct character of each district helps to define it, and helps planners and developers create places that are memorable, with distinct identities and functions. Good design focuses on these aspects, noting that the way a place makes people feel is significantly more important than merely how it looks.

WHAT IS PLACE BASED DESIGN?

A place-based approach to design builds upon a place's character to create places that are responsive to their context and create a desirable sense of place. Designing for place requires a deep understanding of the physical, environmental, social and cultural attributes that make a place desirable, recognising that solutions that work in one place, may not work in another.

Place-based design recognises current values and patterns while enabling change, as envisaged by the planning reform, to create a compact, sustainable, affordable, vibrant and equitable city.

WHY IS PUBLIC SPACE IMPORTANT?

The importance of public space and amenity as part of successful urban outcomes cannot be diminished. The design guides specifically call out public space as a key element to be addressed. When public space is designed well, it provides places for human interaction and activity, including culture, entertainment, sport, recreation and commercial activity.

Streets make up a significant percentage of public space and the role and function of these streets are important to creating urban life and vitality. Streets come in many typologies and take on a variety of functions such as movement, commerce, events, servicing and socialising. Built form also plays a fundamental role in defining the character and quality of streets by forming the edges that define these public spaces, shaping places for pedestrians and creating a human scale environment.

NATIONAL CAPITAL DESIGN REVIEW PANEL

Providing high-quality and sustainable design outcomes is key to the future success of our cities and urban environments. A city must respond to the ever changing demands and needs of those who use it.

Design review is an effective way to improve the quality of built outcomes within our major cities. Design review allows for key development projects and public spaces to be assessed by suitable peers and design professionals to achieve high-quality design outcomes. Design review is an efficient and cost-effective way to improve the design quality of development proposals.

The National Capital Design Review Panel (NCDRP) is an independent and expert panel that provides design advice to the ACT Government, developers and designers for major developments such as buildings, public spaces and public infrastructure projects.

The NCDRP supports decision makers in delivering high-quality, inspiring development and public spaces to meet the needs of the broader community and to ensure integration with the surrounding environment. Through the process of peer-review by a panel of highly experienced design professionals, design review aims to achieve the best possible design outcome for each development proposal that is presented to the NCDRP.

Referencing these design guides and the Design Principles for the ACT, the NCDRP provides a structured process of design review for the provision of independent design advice for the benefit of the proponent, community and city at large.



Campbell urban and public space by Hill
Thalis and Jane Irwin Landscape.
Location: Hassett Park, Campbell ACT.
Architect: Cox Architecture

ACT PLANNING PROCESS

The Territory Plan is a statutory planning document that guides the development and management of land use in the ACT. It sets out the policies and rules for how land can be used and developed including zoning, building height limits, environmental protection and infrastructure requirements.

The Territory Plan has been written through the lens of providing a more outcomes focused planning system. It is accompanied by supporting material such as design guides and planning specifications to deliver a more efficient development assessment process that focuses on developing high-quality built outcomes for Canberra.

The ACT Government has several strategies and frameworks that highlight the direction and vision for the city. Although not statutory in weight, these have been considered and referenced throughout these design guides to direct proponents to further information regarding the key ideas and initiatives where necessary. A list of these documents is provided in the appendices.

The application of the Urban Design Guide, Housing Design Guide and Biodiversity Design Guide spans a range of project typologies and scales - including both public and private developments. This includes and extends beyond the design and delivery of municipal infrastructure projects and assets that might be handed over to Government. As such, the design guides and the Municipal Infrastructure Standards (MIS) should be considered alongside each other. Note for municipal infrastructure projects, the design guides are not intended to replace the MIS and these should be used where required through the course of planning and delivery processes including with referral agencies.

Design guides may provide guidance that goes beyond the requirements set in the Municipal Infrastructure Standards (MIS) for the design of municipal infrastructure. Proponents will still be required to provide a design response to the design guide.

HOW THESE DESIGN GUIDES RELATE TO THE TERRITORY PLAN

The design guides are a key element in the new planning system that will help improve the planning and design of streets, public spaces and residential development in the ACT. The design guides do not form part of the Territory Plan, but must be considered if the Territory Plan's assessment outcomes are to be achieved.

The guides support the development and interpretation of statutory policy by providing clear written and visual guidance to help proponents interpret the expected outcomes, while supporting an outcomes-based approach for development assessment.

District Strategies

District Policies

Zone and other policies

Design Guides

District Planning specifications

Zone Planning specifications

DEVELOPMENT APPLICATION PROCESS

Proponents should consistently consider the Territory Plan (including the relevant design guides) when preparing plans and DA documentation, including for pre-DA matters such as presentation to the NCDRP.

To help the development assessment process, proponents should consider and respond to the design guides at the beginning of the design process. This will allow flexibility in addressing key recommendations from the guide.

When preparing any plans and documentation, proponents must demonstrate their approach and how they have addressed the relevant elements of both the Urban Design Guide and the Housing Design Guide where required. This must be done before going to the National Capital Design Review Panel (NCDRP) and after NCDRP advice if relevant, and be part of their DA submission.

Reference and use of the guidelines would ultimately be made at design review as part of the proponent presentation to the panel. The panel would reference the design guides as a tool to achieve optimum design outcomes for each design proposition, however, would not be seeking a demonstration of methodology to address elements in the guides.

Applicable development thresholds for NCDRP would, by default, then apply to the use of the design guides.



Grace, Dickson, ACT. Design: The Mill Architecture and Design

HOW TO USE THESE GUIDES

This design guide communicates the ACT Government’s intent to deliver high-quality best-practice design outcomes across new developments within Canberra. The design guides demonstrate how a broad range of development outcomes can support the delivery of better outcomes for the ACT.

WHO IS THIS DESIGN GUIDE FOR?

This design guide is intended for developers, design industry professionals, government officials, institutions, community advocates and generally anyone involved or interested in the planning, design and delivery of built environment projects in Canberra.

This design guide is a key tool for developers when briefing design consultants, assessing proposals, making decisions, advocating for change and targeting investment.

HOW IS THE DESIGN GUIDE STRUCTURED?

The Urban Design Guide and the Housing Design Guide work in parallel. They have the same structure for clarity and ease of reference, by seven key themes that directly flow through to the Territory Plan and associated technical planning specifications.

WHAT DOES THE DESIGN GUIDE APPLY TO?

The Urban Design Guide contains design guidance for all seven themes, which relate to the scale from suburbs, precinct, section and block. The Housing Design Guide contains detailed design guidance for the three themes that relate to residential developments at a block and building scale and refers to the Urban Design Guide for specific guidance where there is overlap between the two design guides at a block scale.

While the Urban Design Guide focuses more on the broader spatial and public space outcomes and the Housing Design Guide focuses primarily on the built form and housing components, it is the interface between the built and public space that is the most critical for success in any city, neighbourhood or street. To this extent, the Housing Design Guide will reference the Urban Design Guide in areas of significant cross-over to ensure the successful integration between the two scales. The themes are outlined on the next page, and the areas of implementation relevant to both guides are outlined.

WHAT TYPOLOGIES DOES THIS DESIGN GUIDE APPLY TO?

The Housing Design Guide applies to residential building typologies including dual occupancies, townhouses and apartments, as well as mixed-use typologies when the predominant use is for residential. Predominant use would mean that the typology is mostly residential with a small proportion of alternative uses likely at the ground level.

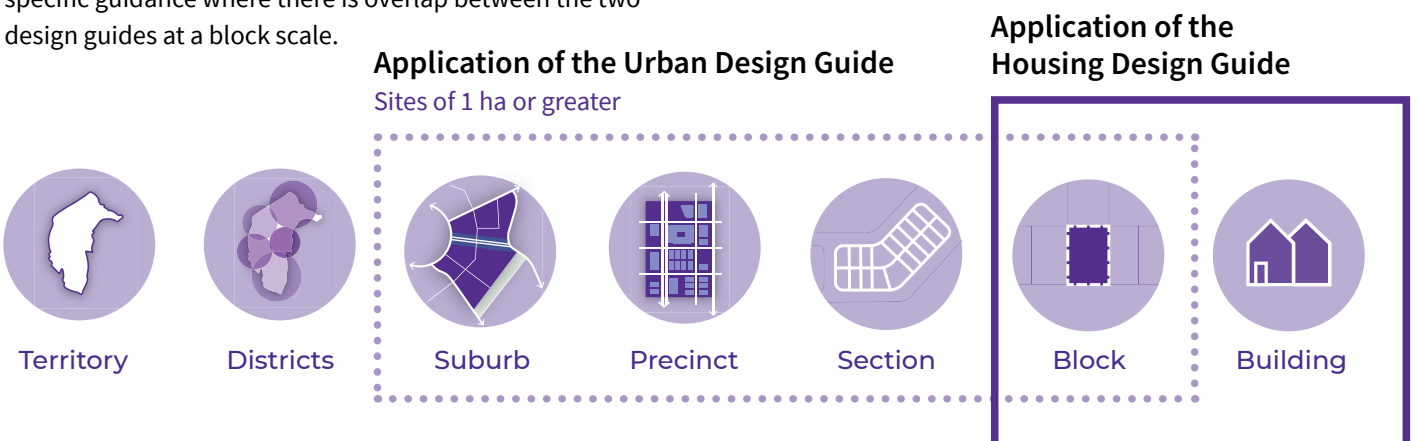

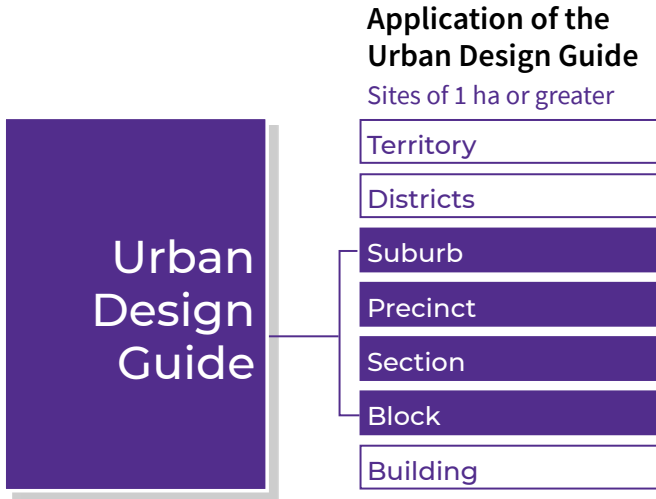

Application of the Urban Design Guide

The zone of influence of the Urban Design Guide

Urban Design Guide will directly influence:

- precinct planning
- planning proposals
- subdivision development applications

Urban Design Guide can inform:

- district strategies and district policies
- changes to the Territory Plan

Urban Design Guide



Application of the Housing Design Guide

All buildings and building sites

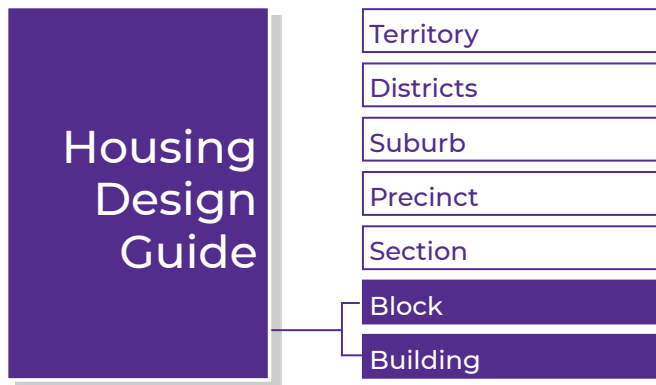

Application of the Housing Design Guide

The zone of influence of the Housing Design Guide

Housing Design Guide will directly influence:

- residential development planning
- residential component of mixed-use developments
- preparation of development applications

Housing Design Guide can inform:

- residential building design best practice
- building feasibility studies.

Housing Design Guide

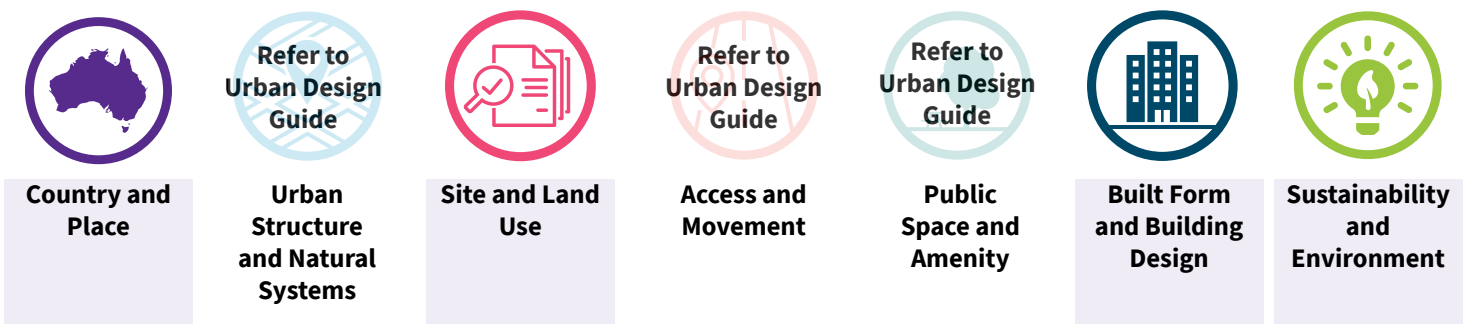

TERRITORY PLAN ASSESSMENT OUTCOMES

The Territory Plan outlines assessment outcomes for proposed development that align to each of the key themes. Proponents must address these assessment outcomes and provide clear plans and documentation to support how these have been achieved through development application. The design guides provide clear guidance to support the proponent in delivering great design that achieves the assessment outcomes.

Application of this design guide:

- Development must be consistent with assessment outcomes.
 - Development must consider and provide a design response to those design guides as notified by the Minister pursuant to section 50 in the Planning Act which includes but not limited to the Urban Design Guide, Housing Design Guide and Biodiversity Sensitive Urban Design Guide.
- Development is required to consider and provide a design response to the Urban Design Guide where:
 - it is precinct scale with a site area greater than one hectare;
 - the combined development gross floor area exceeds 10,000m²;
 - comprises more than 1,000m² of public or common space; or
 - required to seek advice from the Design Review Panel.

Residential development, excluding single dwelling housing, secondary residence and extensions and alterations to multi-unit housing (of no more than 50% increase in floor area), is required to **consider and provide a design response** to the **Housing Design Guide**.

In demonstrating **consistency** with the **assessment outcomes**, proposed development must demonstrate consideration of the design guidance provided in the Housing Design Guide for each of the themes. This includes consistency with the assessment outcomes, noting the following **design elements** have an elevated weighting:

- visual privacy and building separation,
- solar and daylight access,
- common circulation and spaces,
- apartment size and layout,
- ceiling heights,
- private open space and balconies, and
- natural ventilation,

In demonstrating consistency with the assessment outcomes, proposed development must **demonstrate consideration** of the design guidance provided in the guide for the following **themes**:

- country and place;
- urban structure and natural systems;
- site and land use;
- access, movement, and place;
- public space and amenity;
- building design and built form;
- sustainability and environment

Projects may have different design responses to the assessment outcomes depending on the nature of the development and the Urban Design Guide and Housing Design Guide provides design guidance that identifies and describes how they can be met.

Technical planning specifications provide measurable and quantitative guidance, and if met, will be taken to achieve the stated assessment outcome. Note, not all assessment outcomes are covered by a design guide and/or a technical planning specification.

Development may be required to consider and provide a design response to the **Biodiversity Sensitive Urban Design Guide**. Refer to the development thresholds outlined in the **Biodiversity Sensitive Urban Design Guide** for the application of this guide.

The following pages refer to assessment outcomes specific to the Urban Design Guide.

Please also refer to associated documentation required by the design response at the development application stage. This includes any relevant tables that provide further details of assessment outcomes supported across multiple design elements which may need to be considered in providing a response.

TERRITORY PLAN ASSESSMENT OUTCOMES - HOUSING DESIGN GUIDE

URBAN STRUCTURE AND NATURAL SYSTEMS



URBAN STRUCTURE AND NATURAL SYSTEMS

Biodiversity connectivity is maintained across the landscape.

Loss of native habitat and biodiversity is avoided and/or minimised.

The health and functionality of waterways and catchments is maintained, including through application of water sensitive urban design principles.

SITE AND LAND USE



SITE AND LAND USE

The functionality and usability of the development is appropriate for its intended purpose/use.

The proposed use and scale of development are appropriate to the site and zone.

Adverse impacts of development on surrounding uses (both within a site and on adjoining sites) is minimised and residential amenity protected. This includes between residential uses and between non-residential and residential uses.

ACCESS AND MOVEMENT



ACCESS AND MOVEMENT

The functionality and layout of the development is accessible and adaptable, while achieving good connections with the surrounding area. This includes consideration of passive surveillance.

The development encourages active travel through safe and convenient access to the active travel network.

Access to, from and within the site permits safe and legible movement while catering for all users (including pedestrians). This includes consideration of vehicle manoeuvrability and access routes.

PUBLIC SPACE AND AMENITY



PUBLIC SPACE AND AMENITY





The development (including the design of outdoor spaces) achieves reasonable solar access and microclimate conditions to public areas and streets to support their use by the community.

Private open space and communal open space provides sufficient space and facilities for residents and visitors to recreate and relax, as well as providing area for service functions. Spaces are readily accessible for a range of activities.

Reasonable levels of active ground floor interface and passive surveillance to public spaces and streets is achieved.

Any advertising or signs are suitable for their context and do not have a detrimental impact on the surrounding area (for instance due to size or light emission).

TERRITORY PLAN ASSESSMENT OUTCOMES - HOUSING DESIGN GUIDE

BUILT FORM AND BUILDING DESIGN	
 <p>BUILDING DESIGN AND BUILT FORM</p>	The height, bulk and scale of the development is appropriate, noting the desired zone policy outcomes and the streetscape. This includes consideration of building envelope and setbacks.
	Reasonable solar access to dwellings and private open space within a block and on adjoining residential blocks is achieved. This includes solar access into main living spaces within a dwelling.
	Reasonable levels of privacy to dwellings and private open space within a block and on adjoining residential blocks is achieved.
	The dwelling mix and the internal size, scale and layout of dwellings in multi-unit housing provide for a comfortable living environment that meets the changing needs of residents. This includes consideration of cross-ventilation and energy efficiency.
	Courtyard walls and fences do not have an adverse impact on the streetscape.
SUSTAINABILITY AND ENVIRONMENT	
 <p>SUSTAINABILITY AND ENVIRONMENT</p>	Sufficient planting area, canopy trees, deep soil zones and water sensitive urban design measures are provided to enhance living infrastructure, support healthy tree growth and minimise stormwater runoff.
	Urban heat island effects are reduced through limiting impervious surfaces and provision of canopy trees and plants.
	Threats to biodiversity such as noise, light pollution, invasive species incursion or establishment, chemical pollution, or site disturbance are avoided or minimised through good design.
	Minimise cut and fill to protect natural hydrological function and limit soil erosion and site disturbance.
	The development considers and addresses site characteristics, including heritage, natural features, topography, infrastructure and utilities.
	Environmental risks, including noise, bushfire, flooding, contamination, air quality or hazardous materials are appropriately considered for the development on the site.
PARKING, SERVICES AND UTILITIES	
 <p>ACCESS AND MOVEMENT</p>	The development provides electric vehicle parking and access to charging locations in multi-unit housing.
	The development provides appropriate end-of-trip facilities in multi-unit housing which includes secure bicycle parking.
 <p>BUILT FORM AND BUILDING DESIGN</p>	Vehicle and bicycle parking sufficiently caters for the development while minimising visual impacts from the street or public space. This includes consideration of parking location, dimensions and number of spaces provided.
 <p>SUSTAINABILITY AND ENVIRONMENT</p>	Waste is appropriately managed on site without having a detrimental impact on residents and the surrounding area.
	The site is appropriately serviced in terms of infrastructure and utility services and any associated amenity impacts are minimised.



Barcelona Apartments, Turner ACT.
Design: Guida Moseley Brown Architects



Part Two: Design guides



COUNTRY AND PLACE

The Ngunnawal people, their culture and relationship to Country are foundational elements for all design projects in the ACT.

DESIGN ELEMENTS

1.1 NGUNNAWAL CULTURAL RESONANCE

1.1A Governance, process, and
engagement

1.1B Buildings, spaces and landscape
character

1.1C Wayfinding and navigation



A 'Welcome to Country' sequence incorporated into the landscape design features carvings by local First Nations artists.

Photo 1: National Museum of Australia.
Design: T.C.L. Photo: T.C.L

1.1 NGUNNAWAL CULTURAL RESONANCE

The interconnections between the Ngunnawal people, the landscape and all its value past, present and future is a foundational element of planning for the future development of the ACT.

Canberra has a rich Aboriginal history, dating back thousands of years before European settlement. The Ngunnawal people are the rights holders of the Canberra region and have strong cultural and spiritual connections to the land, rivers, and forests in and around the city.

DESIGN GUIDANCE

1.1A GOVERNANCE, PROCESS AND ENGAGEMENT

- i. Consider facilitating authentic and inclusive engagement and consultation processes with Ngunnawal people throughout the design and development process, particularly in the project's early stages to enable a holistic suite of strategy and design responses.
- ii. Recognise and respect Ngunnawal people as rights holders in the ACT, their sovereignty, governance, ways of knowing, thinking and being, their social and cultural practices, their priorities and concerns, and their meanings and values – facilitating safe and welcoming environments for co-creation.
- iii. Work alongside Ngunnawal Traditional Custodians of Country to protect, restore and manage sites of cultural significance through Connection to Country conversations with the Ngunnawal knowledge holders as deemed appropriate.
- iv. Incorporate the aspirations of Ngunnawal people into decision making, planning and management to acknowledge, celebrate and incorporate Ngunnawal values, meanings and culture that reflect whatever contemporary Ngunnawal decision-makers choose these elements to be.
- v. Acknowledge the structural inequality caused by colonial processes and the ways in which these have elevated and prioritised Western practices and knowledge structures to illuminate ways to move forward together in collaboration with The Ngunnawal people.
- vi. Deploy engagement tools that allow Ngunnawal people as knowledge holders to clearly contribute to projects in ways that are meaningful and beneficial to them.
- vii. Facilitate culturally appropriate engagement with the diverse First Nations people living in the ACT to collaborate on and contribute design perspectives respecting and valuing Ngunnawal Traditional Custodians' rights and protocols as decision-makers for Country.
- viii. Collaborate with Ngunnawal and ACT First Nations people to explore diverse employment, business and research opportunities.
- ix. Ensure community health and social services are available within the community.
- x. Explore opportunities to incorporate Ngunnawal land management techniques into natural areas to facilitate employment opportunities and restorative landscape outcomes.
- xi. Extend project partnerships and explore skill sharing opportunities to facilitate opportunities for stronger Aboriginal community networks.

Why this is important:

Completely and respectfully recognising Ngunnawal and First Nations people – their sovereignty, governance, ways of knowing, thinking and being, their social and cultural practices, their priorities and concerns, and their meanings, values and place as a contemporary and living culture – is fundamental in reconciliation, learning and enriching the lives of all Australians on all levels.

Exemplar:

A 'Welcome to Country' sequence incorporated into the landscape design features carvings by local First Nations artists.

Photo 2: National Museum of Australia. Design: T.C.L. Photo: T.C.L



1.1B BUILDING, SPACES AND LANDSCAPE CHARACTER

- i. Identify and protect significant tangible and intangible Ngunnawal heritage, historic and environmental values to safeguard Ngunnawal histories, cultural values, narratives and knowledge systems for future generations.
- ii. Reflect cultural and heritage values through creative interventions and responses in built form and public spaces to incorporate Ngunnawal knowledge, stories and history of place and landscape into the urban environment.
- iii. Incorporate space for art, structures, planting, installations and embedding language to create both formal and informal opportunities for learning.
- iv. Showcase native endemic species to celebrate Ngunnawal ecologies and strengthen the sense of place.

Tip: Ensure cultural safety in public space

The design process must encourage cultural safety and ensure that spaces express and resonate with First Nations communities. Cultural safety requires that we do not speak for others or on behalf of others without their approval. Cultural safety creates a space for those who are often silenced to voice their concerns and a space for those who, historically, have been excluded. Cultural safety provides time for all who need to be heard. Cultural safety ensures that all expressions of culture are enabled, irrespective of personal opinions.

Daniele Hromek, What is cultural safety and how do we design for it?, Architecture AU 23rd Jan 2023

1.1C WAYFINDING AND NAVIGATION

- i. Incorporate Ngunnawal language and, where culturally appropriate, First Nations language through place naming and signage to improve community understanding of First Nations' histories and geographies, while strengthening a sense of place.
- ii. Consider use of illumination, lighting, projections, and digital technologies to create memorable landmarks.
- iii. Integrate artworks and languages through key spaces and routes.
- iv. Preserve and emphasis historic sight lines through articulation of key spaces and built form.



Exemplar:

The planting strategy acknowledges and preserves the native landscape, providing a "window to the past" for the local Aboriginal Guringai people.

Photo 3: St Leonards Health organisation Relocation. NSW. Design: Arcadia, Photo: Paul McMillan.



URBAN STRUCTURE AND NATURAL SYSTEMS

Respond to the key natural and built features of the place to create amenity and comfort for residents.

The built form should respond to and contribute to a place's special characteristics, qualities and context to create bespoke design outcomes that sensitively integrate the project into its respective place. Understanding the varying scales and inter-relationships will allow informed decisions that positively shape the development and its areas of influence.

DESIGN ELEMENTS

Refer to the relevant themes of the Urban Design Guide as listed below for guidance around Urban Structure and Natural Systems

2.1 OPEN SPACE NETWORK

- i. UDG:
 - **2.1B** Type, size, quality, function and connectivity
 - **2.1C** Topography and views

2.2 NATURAL SYSTEMS

- i. UDG:
 - **2.1A** Natural systems
 - **2.2A** Connectivity and access
 - **2.2B** Water management
 - **2.2C** Restoring ecology
 - **5.3C** Positive engagement with nature
 - **5.3D** Biodiversity habitats
 - **7.1A** Water sensitive urban design



Bridgepoint Apartments,
Kingston Foreshore ACT.
Design: KRM/Colin Stewart
Architects



SITE AND LAND USE

Ensure proposed use and scale of development are appropriate to the character, site and zone.

The planning, design and delivery of urban design, public space and built form outcomes should be informed by the city drivers and planning outcomes that respond to the city shape, form, amenity, landscape character and climate. Design outcomes must focus on place-led outcomes that are guided by the Territory's overarching principles and objectives. New approaches to the way we plan for changes in the urban environment, particularly through co-designing opportunities and smart technology data, will help create high quality environments, improved public life and better outcomes on service delivery.

DESIGN ELEMENTS

3.1 SITING

- 3.1A** Solar orientation
- 3.1B** Prevailing winds and cross ventilation
- 3.1C** Setbacks and separation
- 3.1D** Privacy and outlook

3.4 PRIVATELY OWNED PUBLIC SPACES (POPS)

- 3.4A** POPS general
- 3.4B** Parks and plaza
- 3.4C** Forecourts
- 3.4D** Landscaped setbacks
- 3.4E** Cross-block connections
- 3.4F** Laneways
- 3.4G** Arcades/interior connections
- 3.4H** Courtyards

3.2 BUILT FORM

- 3.2A** Building floorplates, depth and articulation
- 3.2B** Building heights

3.3 STREET INTERFACE

- 3.3A** Building to street interface
- 3.3B** Building entries
- 3.3C** Vehicles and servicing
- 3.3D** Façade, massing and modulation
- 3.3E** Lower storeys above ground floor (up to four storeys)
- 3.3F** Setback to street
- 3.3G** Ground level
- 3.3H** Materiality



3

Location: Kingsborough
Village, Kingston ACT.
Developer: John Gasson

3.1 SITING

Actively respond to climatic conditions and solar orientation to improve a building's energy efficiency, comfort and performance.

Building and site orientation has significant impacts on a building's energy efficiency, comfort and overall building performance. Good design responds to the site's natural features and climatic conditions, considering both the sun and wind pathways for different times of the year, and how best to use these by either taking advantage of or protecting from their effects.

DESIGN GUIDANCE

3.1A SOLAR ORIENTATION

- i. **Ensure new housing development is consistent with solar and daylight access requirements as solar access and daylight access have elevated weighting.**
- ii. Reduce the operational energy demands of buildings by incorporating passive solar design principles to reduce the need for heating and cooling.
- iii. Maximise the number of dwellings that have a northerly aspect, where possible, to take advantage of natural solar access and reduce energy use.
- iv. Orient buildings to enable windows to access direct daylight throughout the year and time of day.
- v. Orient daytime living areas towards the north wherever possible to allow for direct solar access in winter, with shading in summer to prevent overheating.
- vi. Minimise overshadowing to public open space and neighbouring residential properties to allow sunlight access and maximum exposure to living areas, communal spaces and private open spaces.
- vii. Use building form, setbacks and window locations to limit views into habitable rooms and private open spaces while protecting access to daylight and outlook.
- viii. Design developments to meet the objective of The built form and building design elements of the relevant Territory Plan policies.
- ix. Incorporate operable skylights where possible in dwellings located on the top floor, to maximise access to daylight and ventilation.

3.1B PREVAILING WINDS AND CROSS VENTILATION

- i. Capture prevailing winds through built form to create more sustainable and comfortable living environments.
- ii. Locate and position communal and private open spaces to be protected from downdrafts and the wind tunnel effect during winter.
- iii. Include operable windows and balconies that can capture prevailing winds where possible.
- iv. Consider size and shape of built form to capture or block prevailing winds.
- v. Ensure building separation is adequate to capture prevailing summer breezes and enable natural cross-ventilation to dwellings.
- vi. Consider orientation and spacing of buildings on site to avoid creating wind tunnels.

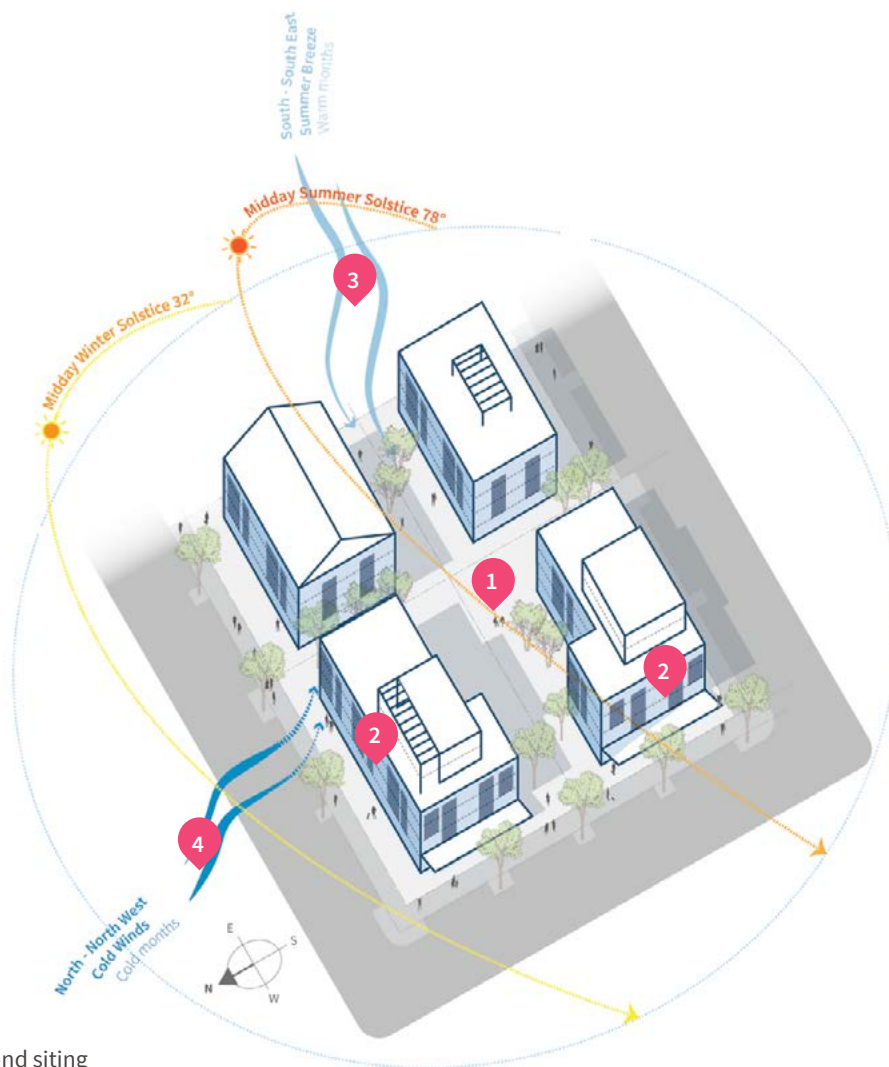

Figure 1: Built form and siting

- 1 SOLAR ACCESS**
Orient building mass to maximise solar access and avoid overshadowing of neighbouring buildings and open space
- 2 WINDOWS AND SHADING**
Consider window placement and operable shading devices adapted to orientation
- 3 SUMMER BREEZE**
Orient buildings to capture summer breeze
- 4 WINTER WIND**
Orient buildings to minimise negative impact of cold winds to private and communal open space

Tip: Microclimate assessment

Microclimate assessments are the best way to design and develop urban heat responses specifically for your site. Microclimate assessments will provide site-specific guidance on elements such as the optimal use of tree canopy cover, cool materials, and built form / orientation to maximise energy efficiency, improve thermal comfort and mitigate against the urban heat island effect. You can use micro-climate assessments at all stages of a project, from early site investigations to maintenance and renewal on existing developments, and at all scales— from block to precinct, and above.

The ACT Government has published information on the different kinds of microclimate assessments and advice on choosing the best kind of assessment for your site in the Microclimate Assessment Guide.

Lower value or community-led projects should focus on free and simple methods, whereas high value projects like major developments should undertake a combination of methods, including more sophisticated modeling (where relevant).

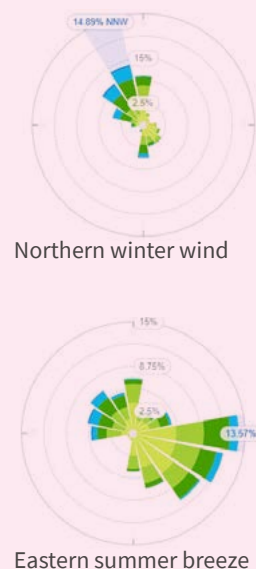

3.1C SETBACKS AND SEPARATION

- i. **Ensure new housing development is consistent with visual privacy and building separation requirements as they have elevated weighting.**
- ii. For some site conditions, building separation and setbacks may need to be increased beyond the minimums noted to achieve adequate solar access, avoid overshadowing of public space and overlooking of neighbouring properties, and accommodate future street widening.
- iii. Ensure setbacks and building separation distances increase proportionally with building height to ensure solar access and view to sky.
- iv. Use setbacks and separation between buildings to reduce urban heat island effect, through use of permeable surfaces, minimising hardstand areas and minimising extent of driveways and vehicle circulation areas.
- v. For some site conditions, building separation and setbacks may need to be increased beyond the minimums to protect environmentally important / sensitive ecosystems or critical wildlife habitats, for example riparian corridors, wetlands or grasslands / woodlands including mature native trees.
- vi. For some site conditions, building separation and setbacks may need to consider how to avoid habitat fragmentation.
- vii. For some site conditions, building separation and setbacks may need to be increased to minimise the likelihood of invasive species incursion into adjacent ecosystems, or the impacts of increased visitor use, flood or fire risk.



Tip: Dense living without tall buildings

Designing for maximum quality of outlook while maintaining privacy in denser urban environments with tight proximities can be a challenge. Clever juxtapositions of different building typologies can provide a high degree of amenity for residents living densely while also creating an interesting environment between the buildings at a human scale.

Photo 4: Shophouse, Kingston ACT. Design: Judd Studio.

Related planning strategies and tools:

- i. Refer to the Housing Design Guide Theme 3– Natural light and ventilation.
- ii. Refer to Planning specifications ZS1, ZS2 and ZS4.

3.1D PRIVACY AND OUTLOOK

- i. **Ensure new housing development is consistent with private open space and balcony requirements as they have elevated weighting.**
- ii. Orient and site buildings to minimise the impact on neighbouring sites and properties and avoid overlooking to and from neighbour's private open spaces.
- iii. Orient and site buildings to maximise long views from new private open spaces.
- iv. Site buildings to capture desirable views to natural aspects such as lakes, parks, ranges and landmarks to enhance outlook and connection to context for residents.
- v. Ensure building separation is adequate to capture prevailing summer breezes and enable natural cross-ventilation to dwellings.

Tip:

While overlooking private open spaces is not ideal, sharing a view to a communal open space, such as shared courtyard, shared front gardens and podium landscape can contribute to a shared sense of community and invite neighbours to interact.

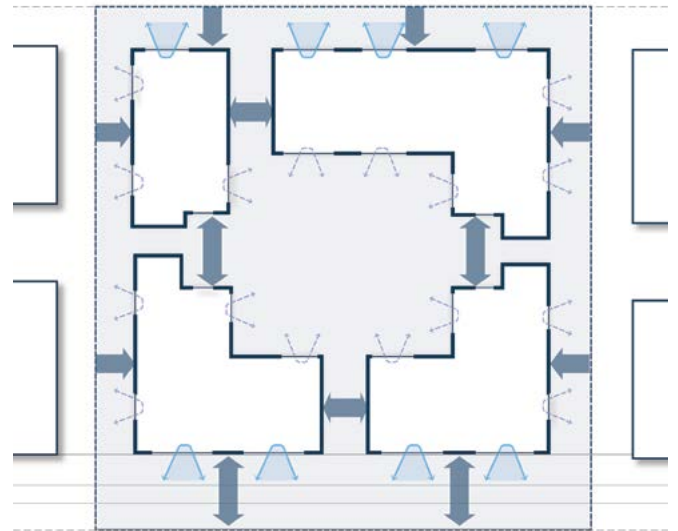

Figure 2: Appropriate setbacks to neighbouring sites and separations within a development area to ensure maximum outlook amenity for dwellings, streets interface and the open spaces between the buildings.

Related planning strategies and tools:

- i. Refer to Planning specifications ZS1, ZS2 and ZS4.



Exemplar : Maximising views

Maximising long views from as many dwellings as possible while avoiding direct overlook onto private outdoor space. The consistent building height and upper-storey setback allows neighbouring buildings to enjoy the view too.

Photo 5:
Sapphire Apartments,
Kingston Foreshore ACT.
Design: May and Russell
Architects

DESIGN ELEMENT:

3.2 BUILT FORM

Actively respond to climatic conditions and solar orientation to improve a building's energy efficiency, comfort and performance.

Building and site orientation has significant impacts on a building's energy efficiency, comfort and overall building performance. Good design responds to the site's natural features and climatic conditions, considering both the sun and wind pathways for different times of the year, and how best to use these by either taking advantage of or protecting from their effects.

DESIGN GUIDANCE

3.2A BUILDING FLOOR PLATES, DEPTH AND ARTICULATION

- i. Provide building depth that allows for optimal cross-ventilation, daylight access, building separation, landscaping and views to as many dwellings as possible.
- ii. For a mixed-use building, design building depth to be appropriate for non-residential uses on ground and lower levels.
- iii. Use building articulation and break down visual bulk and scale of larger floorplates and buildings to positively contribute to surrounding public space and buildings.

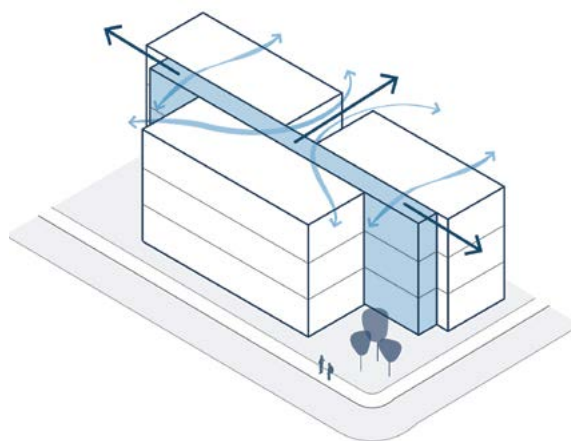

Figure 3: Breaking down building depth and massing to improve natural ventilation and access to daylight.

Tip: Setbacks and separation

Any development will need to accommodate appropriate setbacks and building separation for any given site condition. Shaping, staggering and adjusting built form improves visual amenity, communal open space amenity and public space.

Why this is important

Ensuring a built form outcome that contributes positively to its surroundings while avoiding any negative impacts on its neighbours is critical in supporting a positive urban experience at a human scale.

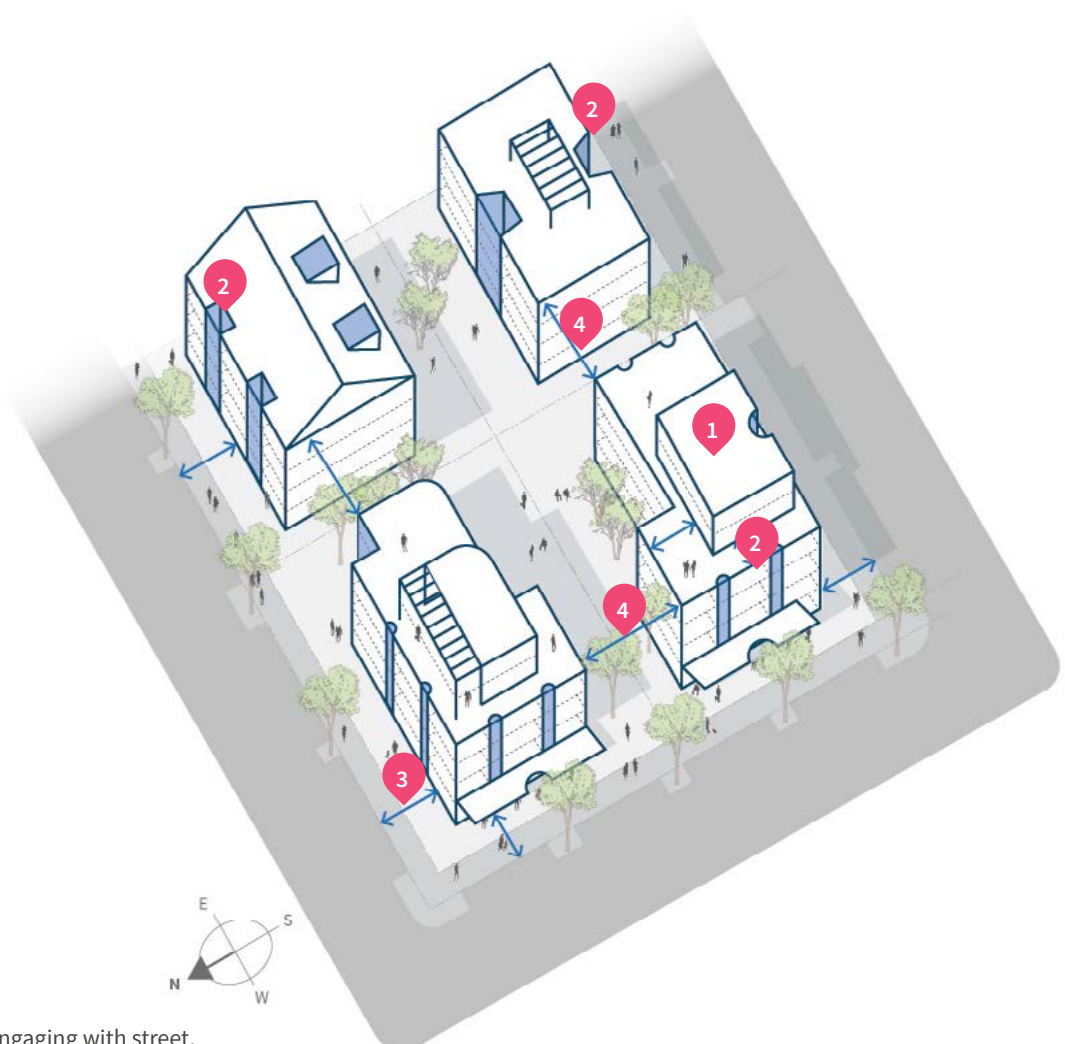

Figure 4: Engaging with street.

- 1 BUILDING DEPTH**
Achieve optimised solar access, natural ventilation, circulation, views and street presence.
- 2 BUILT FORM ARTICULATION**
Reduce perception of large built form to create a pleasant experience at human scale.
- 3 SETBACKS**
Appropriate setback to street and neighbouring sites.
- 4 SEPARATION**
Appropriate separation to avoid overshadowing, overlooking and allow sufficient ventilation.

3.2B BUILDING HEIGHTS

- i. **Ensure new housing development is consistent with solar and daylight access requirements as they have elevated weighting.**
- ii. Consider appropriate building heights that relate to neighbours and location-specific features such as natural landforms, heritage items or existing built form.
- iii. Respect the rhythm of the streetscape through built form scale and texture by referencing datums, floor-to-floor heights, setbacks and massing of adjacent built form outcomes.
- iv. Consider smaller floor plates to help to blend larger new developments into any existing finer grain streetscapes. This can be achieved using recesses, stepping back and texture to break down the apparent scale of new development.
- v. Consider appropriate building height that allows for adequate daylight and solar access to dwellings as well as neighbouring dwellings and open spaces (public or private), while capturing key views from dwellings and common spaces.
- vi. Consider and respect neighbour's view lines with appropriate building height, setbacks and siting.

- vii. Accommodate all building programs including rooftop communal space, lift overrun, plant and articulated roof within the permissible height limit outlined in the relevant Zone and District Specifications within the Territory Plan.
- viii. When generating building heights, consider flexible floor-to-floor ceiling heights at the lower levels to allow for future adaptability.

Tip: Be a good neighbour

Maintaining an appropriate building height and built form is about being a good neighbour and ensuring a positive human scale experience at ground level. Maintaining a consistent, lower building height typically ensures that any new building is not causing undesirable micro-climate impacts on adjacent streets or, open space or limits neighbours' access to sunlight.

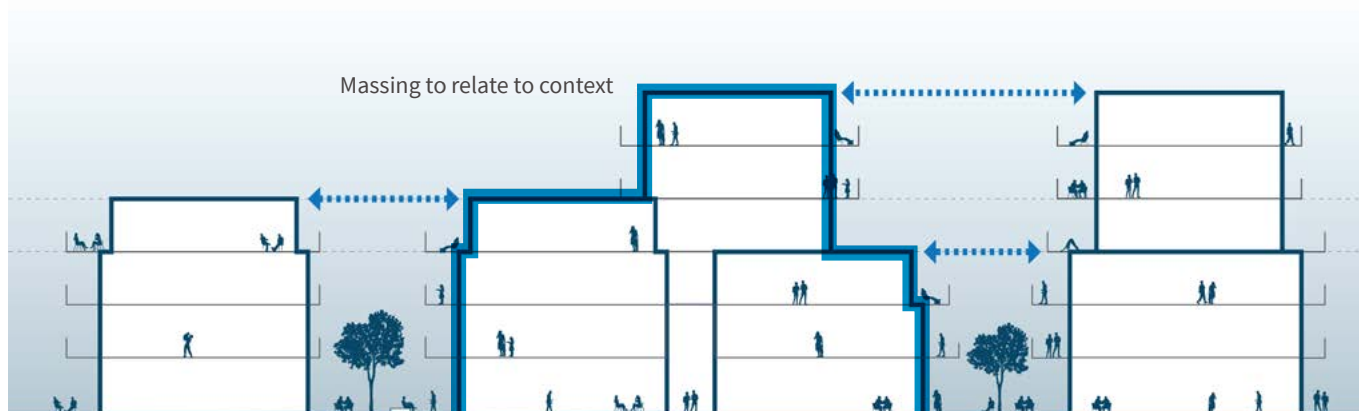

Figure 5: Relating to contextual building heights.



Exemplar: Building height

A consistent street wall height at a human scale creates a well-defined street and pleasant environment. Visual interest is achieved through architectural articulation rather than building heights and street setbacks.

Photo 6: Provan Street, Campbell ACT. Architect: Cox Architecture

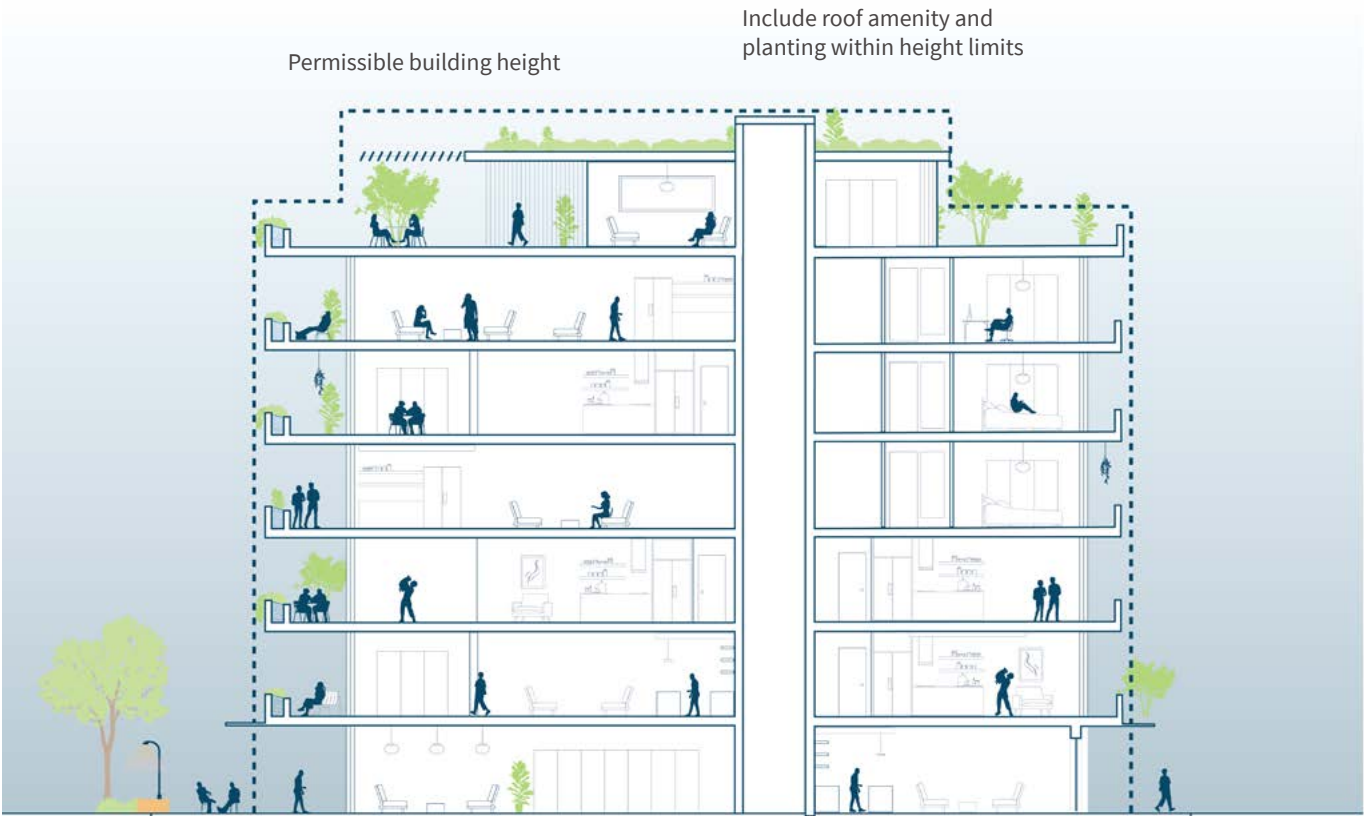

Figure 6: Building articulation within permissible building envelope.

3.3 STREET INTERFACE

Built form should engage with the street to create active and vibrant street edges.

The design of ground floor edges is key to the life of our streets and places. Well- designed building edges at a ‘human-scale’ provide a positive experience and encourage people to engage more with what is happening both inside the building and on the street. Built form should engage with the street wherever possible to maintain an active and vibrant street edge.

3.3A BUILDING TO STREET INTERFACE

- i. Define built form edges and setbacks relative to the intended urban pattern, adjacent buildings, desired streetscape and neighbourhood character.
- ii. Establish a street frontage setback alignment that contributes to the intended character and amenity of the public space.
- iii. Use front setback areas to incorporate a deep soil zone that allows for large, long-lived shade trees that provide privacy for ground floor residents and contribute to the green amenity of the street.
- iv. Consider secondary upper-level building setbacks and separation to reinforce the desired streetscape and building scale for the public space.
- v. Maximise street activation and passive surveillance through active street frontages and the design of ground floor dwellings.
- vi. Provide a seamless transition from public space to private spaces.

- vii. Include public amenity, landscaping and active uses on street frontages to animate street life and soften interface with new development.
- viii. Provide a clear sense of address through clearly defined building entries that are easily visible and identifiable from the street.

Why this is important:

Providing ground floor dwellings facing the street with individual entrances and front gardens contributes to animating the street. It gives residents direct access to ‘their’ private outdoor space, increases perceived safety in the street and creates more opportunity for neighbours to incidentally meet, fostering a better sense of community.

Tip:

Providing a sense of privacy for ground floor residents is important for residents’ comfort in urban environments. Slightly raising the ground floor level or filtering views through planting and front courtyards provide privacy while maintaining presence on the adjacent street and public space. Failing to provide privacy will often lead to residents living with closed blinds, thereby reducing passive surveillance to the streets and light quality in the dwellings.

Photo 7: Townhouses in Deakin, ACT. Design: Stewart Architecture.



Tip: Housing choice in Canberra's suburbs

Providing new building types of higher dwelling density in established suburbs in Canberra is key to provide variety of housing choice, sustainable buildings and to better leverage existing infrastructure and contribute to making Canberra healthier and more sustainable. The densification of the suburbs can happen incrementally through multi-unit developments such as dual-occupancy dwellings, townhouses, smaller apartment developments and other innovative mixed medium-density typologies sensitively integrated into surrounding suburban character.



Photo 8: The Village, Rivett, Light House Architecture and Science
Photo: Ben Wrigley



Photo 9: Aranda Townhouses, Bandjalong Cr, ACT. DNA Architects.



Photo 10: 3 Torrens Street Braddon, Ring and Associates.
Photo: Hathaway Real Estate

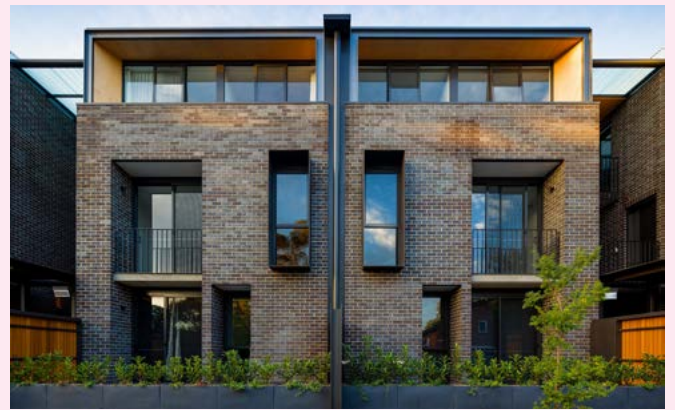

Photo 11: 4 Lowanna Street, Marcus Graham.
Photo: Chalk Studio



Photo 12: 5 MICA Campbell, Stewart Architecture.
Photo: Anne Stroud



Photo 13: 6 2 Barry St, Brunswick VIC, Fieldwork.
Photo: Tom Ross

Photo 8 - Three sustainable and high quality family-sized units on a suburban lot previously occupied by one single family dwelling.
Photo 9- Two-storey townhouses with front garden to the streets and garage space to the back separated by an internal light well.
Photo 10- Small apartment building with a scale sensitive to surrounding single family houses.
Photo 11 -Three-storey infill apartment building with shared

underground parking. The built form is broken down to smaller volumes separated by open walkways with access to each apartment.
Photo 12 - A suitable scale of infill development with a public face, successfully reinterpreting the surrounding suburban character.
Photo 13 - Twenty 3-4 storey townhouses transitions massing and scale to the surrounding Victorian terraces.

3.3B BUILDING ENTRIES

- i. Position building entries to avoid crowding and conflict with areas of significant pedestrian congestion, such as directly adjacent to intersections and crossings.
- ii. Provide more engaging streets by maximising the number of building entries and active frontages on every interface with a street address, including laneways where appropriate and desirable.
- iii. Provide access to the outdoor space immediately outside of ground floor dwellings.
- iv. Provide clearly identifiable building entries to the street and communal spaces with architectural treatment of awnings, paths and the like.
- v. Provide a clear sense of address through clearly marked entries and doorways.
- vi. Have clearly defined and separate access for both pedestrians and vehicles to prioritise safety and pedestrians within the site.
- vii. Consider the journey from street to front door or lobby and provide relief from rain and sun adjacent to entries through architectural elements such as extended awnings, to increase comfort.
- viii. Consider comfort for visitors waiting at the front door (such as guests and delivery people) by providing seating and protection from rain and sun.
- ix. Provide visual connections from the street into lobbies and ground floor so entries are safe, comfortable and user friendly.
- x. Use entries as an opportunity to express identity through tactile material treatment, architectural expression and clear acknowledgement of name or street number.
- xi. Locate visitor bicycle parking and electronic charging near building entrances for ease of access and priority of active travel.

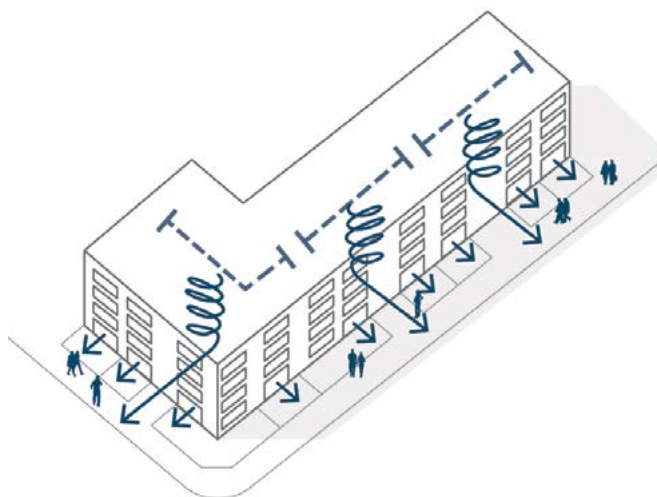

Figure 7: Easy access to the outside with a logical relationship between one's dwelling and the space immediately outside.

Tip: Providing more building entrances along the street edge improves the logical relationship between a dwelling and the space just outside without long detours through corridors and around buildings.

Related planning strategies and tools:

- i. Refer to Planning specifications ZS1, ZS2 and ZS4.
- ii. Refer to Australian Standard AS1428 for accessibility and equal access.
- iii. Refer to area specific policy for car parking and bicycle parking rates.

3.3C VEHICLES AND SERVICING

- i. Make car park entries easily identifiable, but do not let them dominate the building façade or pedestrian entry.
- ii. Locate visitor car parking near the lobby and lifts for better wayfinding.
- iii. Consider the location and access of building services such as hydrant and sprinkler boosters, water meters, etc. to avoid inactive façades in prominent locations.
- iv. Provide safe pedestrian access to refuse and storage, to encourage and enable recycling, container exchange and other waste-minimisation options to be easily used by residents. This should consider access and collection for food organics and garden organics (FOGO) along with bulky waste.
- v. Consider consolidating car parking areas in all scales of residential developments to maximise efficiency of required vehicular circulation area and hard surface and minimise visual dominance of car parking.

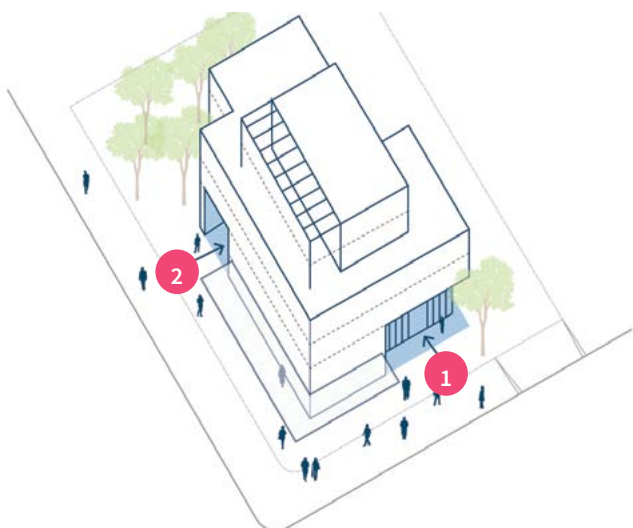

Figure 9: Vehicles and servicing.

1 MAIN ENTRY

For pedestrians should be clearly identifiable and articulated with a sense of address.

2 SECONDARY ENTRY

For bicycles, vehicles, and services should be identifiable but not dominant.

3.3D FAÇADE, MASSING AND MODULATION

- i. Articulate street walls and podiums on long, wide street frontages to create finer-grain massing and modulation of the built form.
- ii. External building articulation and scale progresses from public ground floor to semi-public middle section to private penthouse/tower. These spaces should be articulated to reflect the human experience.
- iii. Articulate vertical massing to create human-scaled, pedestrian-friendly environments.
- iv. Incorporate vertical and horizontal articulation in the built form to create rhythm, visual interest and aesthetic appeal at the interface. Incorporate structures and façade projections that can have a practical as well as aesthetic function.
- v. Adapt articulation to respond appropriately to orientation, climatic conditions, outlook and privacy.
- vi. Articulate built form to respond to important building elements such as pedestrian entries and corners.
- vii. Consider locating balconies and common circulation on frontages that can activate public spaces.
- viii. Adapt the façade articulation on all sides of a building to respond appropriately to the orientation, climatic conditions, views, outlook and privacy.

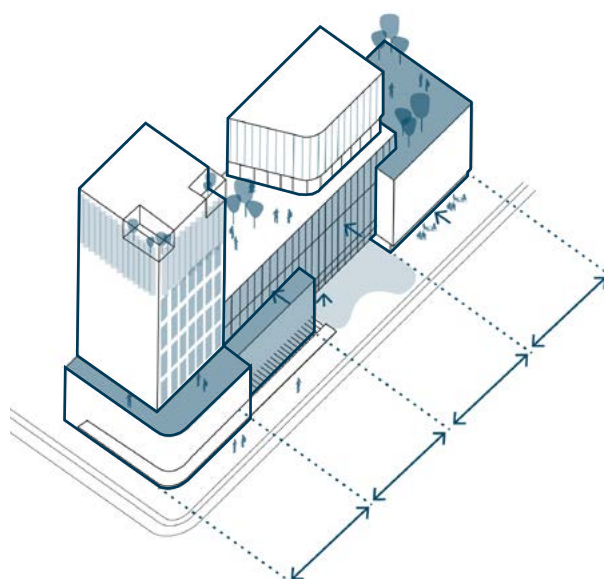

Figure 8: Façade articulation to consider human-scale, street rhythm and visual interest.

3.3E LOWER STOREYS ABOVE GROUND FLOOR (UP TO FOUR STOREYS)

- i. Design balconies to address and engage with the streets and the public space to contribute to the broader sense of activation and passive surveillance of public spaces.
- ii. Incorporate balcony planter boxes into balconies to provide private planting and natural screening when possible.
- iii. Integrate publicly accessible functions in the building's lower storeys to create engaging and activated street edges that overlook the street.

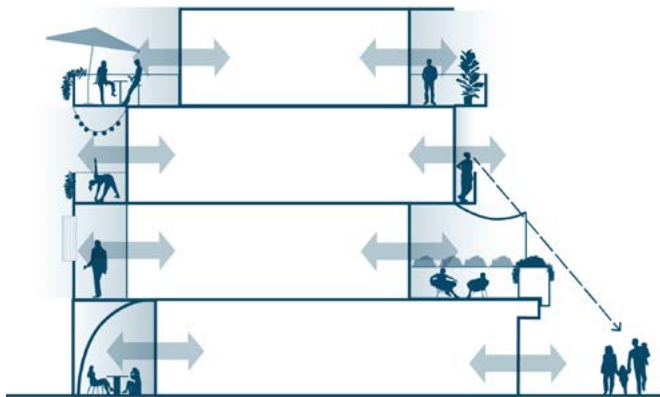

Figure 10: Incorporate direct access to a range of outdoor spaces and experiences that help bring inhabitants closer to nature and the outdoors.

Why this is important:

The opportunity to spend time outdoors becomes increasingly important as our built environments become denser. The everyday experience of being connected to nature is a key fact in overall long-term health and wellbeing.

Related planning strategies and tools:

- i. Refer to the Housing Design Guide Theme 5 – Sustainability and Environment.

3.3F SETBACK TO STREET

- i. Articulate front setback areas where appropriate to create publicly accessible spaces (such as plazas and forecourts) that are able to be used and enjoyed by pedestrians.
- ii. Articulate ground floor setbacks with high-quality materials and urban furniture to create visual interest and positively contribute to the public space.
- iii. Set back upper storeys to ensure appropriate solar access to the street and reduce the visual intensity of taller buildings.



Photo 14: Spill-out of cafe into colonnade space created an active building edge and green visual amenity to the street. Location: Fortitude Valley, Brisbane.



Photo 15: Street setback pocket is inhabited with spill-out of cafe seating and includes convenient bike-parking and water station for pet dogs. Location: Glenlyon Rd, Brunswick, Victoria.

3.2G GROUND LEVEL

- i. Create permeable edges at the ground level to improve passive surveillance of the streets and public areas while creating a more inviting and activated frontage. This goes for both residential and non-residential buildings in active areas.
- ii. Elevate private open space such as terraces or balconies above street level to enable passive surveillance and connection to the street, without compromising privacy.
- iii. Provide clearly identifiable building entry points with architectural treatment of awnings, paths and the like.
- iv. Locate vehicle entry points and loading / servicing bays away from public frontages where possible or ensure they are recessive in the façade design.

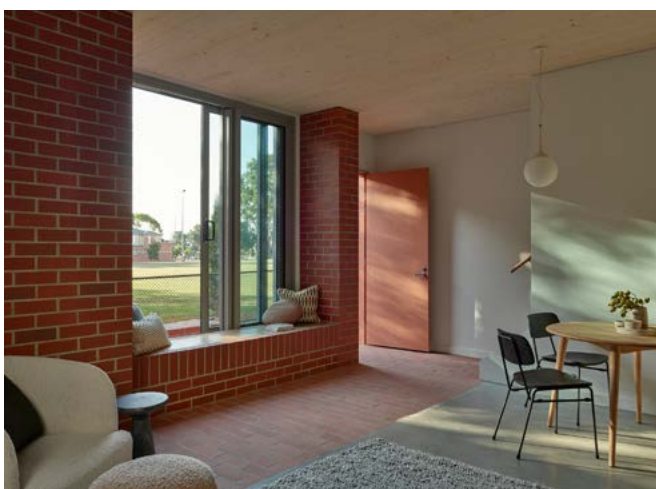

Exemplar: Residential ground floor

A slightly elevated front garden with private entrance to the dwelling animates and activates the ground level, providing passive surveillance while enabling privacy and living quality to the inhabitants.

Photo 16: Balfe Park, Brunswick VIC. Design: Kerstin Thompson. Photograph: Derek Swalwell

3.2H MATERIALITY

- i. Consider immediate context and built form when selecting materials to add to the identity and local character of the place. This can be achieved by referencing local materials, colours and/or finishes.
- ii. Choose robust, durable and low maintenance materials to ensure longevity of the finish, reduce ongoing maintenance costs and provide a high-quality design outcome.
- iii. Consider whole-of-life costs and carbon footprint for prominent features when choosing materials.
- iv. Consider fabrication and installation processes when selecting materials. Products that can be delivered safely and sustainably for their entire life cycle should be used wherever possible.
- v. Provide insulation above minimum requirements of the National Construction Code (NCC) where possible, to help minimise reliance on air conditioning and heating, thus saving energy and money for residents.
- vi. Design floor and wall structures and finishes to provide thermal mass to dwellings where direct sunlight is available with good solar control. This can minimise heating loads in winter without increasing cooling loads in summer.
- vii. Use double glazing or high-performance laminated glass to improve thermal performance of the building envelope without compromising outlook and access to natural light.
- viii. Consider performance of materials in their proposed orientation to avoid high maintenance or replacement costs for more exposed elements.

3.4 PRIVATELY OWNED PUBLIC SPACES (POPS)

Privately owned publicly accessible spaces (POPS) can improve urban environments and add much-needed publicly accessible space in cities.

Privately owned public spaces (POPS) are areas within privately owned buildings or developments that are open to the public. POPS can improve urban environments and provide much-needed public space in cities. POPS can take many forms, including plazas, parks, gardens, atriums, and other outdoor or indoor spaces. POPS provide a range of public and social benefits including increased access to open space, improved pedestrian circulation and a more usable high-quality public space.

DESIGN GUIDANCE

Why this is important:

Commercial, residential and mixed-use developments on large sites are encouraged to provide an appropriate portion of the site area as publicly accessible open space. Private developments are in a unique position to boost the capacity and diversity of the public space. These spaces can make an immense contribution to urban life by significantly improving the pedestrian experience in the city. It is not expected that all new developments include POPS, but they should be considered where possible.

3.4A POPS GENERAL

- i. Privately owned public spaces (POPS) should strengthen and support the urban structure of the broader precinct by creating permeable blocks.
- ii. Provide legible and visible signage to internal courtyards, arcades and interior connections.
- iii. Provide larger, consolidated areas of POPS where possible to foster better flexibility and accommodate social activities and events.
- iv. Locate POPS next to engaging building edges that provide passive surveillance and activating functions that spill out into the courtyard.
- v. Where possible, embed public amenities and other conveniences, such as seating, landscaping, signage, lighting and public art, to respond to the needs of the broader context and network.
- vi. Strategically embed infrastructure where possible, such as 3-phase power and communications infrastructure to allow for a broad range of events and activations.

- vii. Use hardscape materials to integrate with and complement adjacent footpath hardscape treatments to create a continuous public space aesthetic.

3.4B PARKS AND PLAZAS

- i. Plan for park and plaza open spaces to address one or more streets and be highly visible and legible from the street with clear wayfinding and signage.
- ii. Avoid excessive grade changes for parks and plazas from the street level through the public space.
- iii. Ensure that adjacent built form interfaces address the space with engaging edges and allow access to ground floors.
- iv. Configure and articulate building siting and massing so that parks and plazas have adequate solar access.

3.4C FORECOURTS

- i. Design forecourts to be an appropriate depth from the property boundary to allow for pedestrian movement and gathering adjacent to the building entrance.
- ii. Orient forecourts to have at least one edge open to the public footpath.
- iii. Do not allow building entries to be obstructed or visibly obscured by planting or other amenities.

3.4D LANDSCAPED SETBACKS

- i. Where appropriate, incorporate deep planting zones within the setback area to establish larger tree planting that contributes to shade and amenity to the street.
- ii. Prioritise tree planting on north and west sides of buildings to reduce urban heat impacts and to shade building walls with greater exposure to solar radiation.

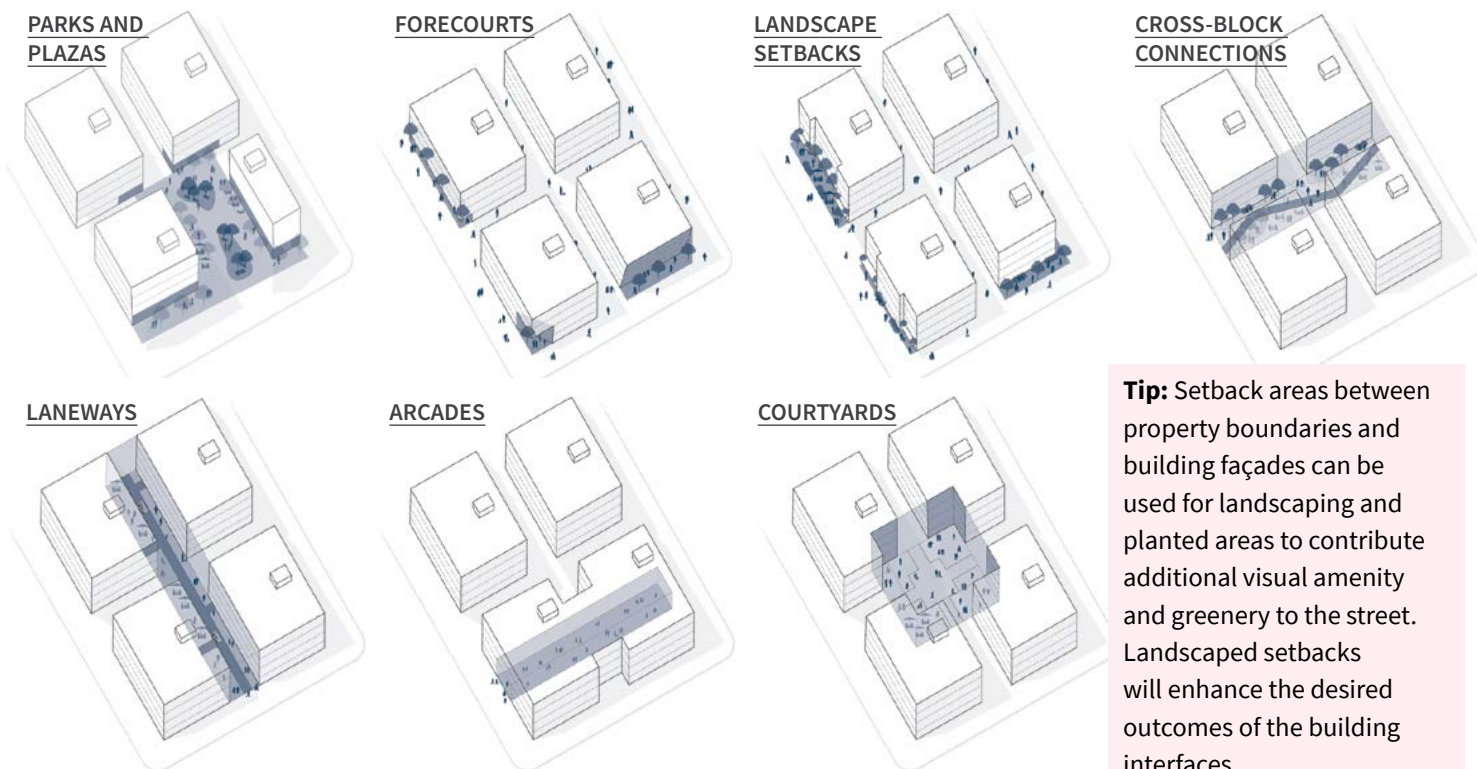

Figure 11: Types of privately owned public spaces.

3.4E CROSS-BLOCK CONNECTIONS

- i. Provide new pedestrian connections through the site on longer blocks to allow for more permeability.
- ii. Keep cross-block connections open to the sky; the scale of adjacent walls should be articulated to provide adequate solar access.
- iii. Where sites address two sides of a block, design cross-block connections to provide clear and direct pedestrian connectivity from one street to the other.
- iv. Provide active building edges where appropriate to encourage safety and activation through passive surveillance.

3.4F LANEWAYS

- i. Design laneways to be an appropriate width to allow for vehicle servicing and back of house movements, while also allowing the flexibility to accommodate for events and activations.
- ii. To improve safety and fine-grain connections, prevent laneways being dead ends for pedestrians.
- iii. Plan for buildings fronting onto laneways to provide passive surveillance and activating functions such as entrances, lobbies, glazed walls and outdoor dining.
- iv. Where appropriate, recess building edges to unlock more public space at the ground level.

3.4G ARCADES/ INTERIOR CONNECTIONS

- i. Align internal connections with the broader urban structure and intent for the movement network.
- ii. Articulate and configure entrances, building massing and signage to be clearly demarcated as welcoming, open and accessible to the public.
- iii. Where appropriate, activate interior connections with functions such as retail, bars, cafes and restaurants and allow for outdoor dining spaces that spill out into arcade.
- iv. Use generous ceiling heights to unlock opportunities for natural light wells and indoor trees and vegetation.

3.4H COURTYARDS

- i. Generally, proportion courtyard spaces with a 1:1 ratio of length to width.
- ii. Keep courtyards open to the sky and articulate built form to ensure appropriate solar access.
- iii. Courtyards should be appropriately sized and articulated to accommodate landscaping.
- iv. Connect courtyards to public areas with clear and legible signage to indicate the courtyard is publicly accessible.
- v. Provide at least two public points of access to courtyards through cross-block connections or publicly accessible interior arcades.



ACCESS AND MOVEMENT

Streets are important places for people to come together and interact.

The interface between buildings and the public space must allow for appropriate levels of movement and activity that meet people's demands and needs. Streets must be adaptable and responsive to future changes in society, climate and technology, while unlocking efficiencies in using and managing resources. New housing should allow residents to easily connect with their surrounding community and environment, while providing pedestrian permeability from within the site, to the street and the broader precinct.

DESIGN ELEMENTS

Refer to the relevant themes of the Urban Design Guide as listed below for guidance around Access, Movement and Place.

4.1 SITE ACCESS AND CONNECTIVITY

On site access

- i. UDG:
 - **6.1A** Block permeability
 - **4.6B** Parking access and entries
 - **4.6H** Access to buildings and parking
 - **4.6I** On site access
 - **4.6J** Green accessways on lots

Cross block links

- ii. UDG:
 - **6.1A** Block permeability
- iii. HDG:
 - **3.4E** Cross-block connections
 - **3.4F** Laneways
 - **3.4G** Arcades / interior connections

4.4 ACTIVE TRAVEL

Safe pedestrian/cycle access

- i. UDG:
 - **4.4A** Safe, inclusive and legible active travel network

4.2 PARKING AND SERVICES

Vehicle access and driveways

- i. UDG:
 - **4.6B** Parking access and entries

Parking

- ii. UDG:
 - **4.6D** Underground parking
 - **6.2D** Sleeved podium parking and services

Electrification and ZE vehicles

- iii. UDG:
 - **4.6G** Electrification and zero emission vehicles

Integrated services

- iv. UDG:
 - **6.2C** Ground floor services and infrastructure

End of trip facilities

- ii. UDG:
 - **4.4C** Supporting infrastructure for active travel
 - **4.6I** On-site access

4.3 ENGAGING WITH THE STREET

Street and building interface

- i. UDG:
 - **6.3** Ground floor edge conditions
- ii. HDG:
 - **3.3A** Building to street interface
 - **3.3F** Setback to streets

Building entries

- iii. UDG:
 - **4.6H** Access to buildings and parking
 - **4.6I** On site access
- iv. HDG:
 - **3.3B** Building entries

Landscaping and canopy cover

- v. HDG:
 - **3.4D** Landscaped setbacks
- vi. UDG:
 - **4.6J** Green accessways on lots
 - **5.3A** Boosting tree canopy and coverage
 - **5.3B** Local planting and vegetation species
 - **5.4B** Landscaped building interface



4

Ori Building, Lonsdale Street, Braddon, ACT.
Design: Judd Studio



PUBLIC SPACE AND AMENITY

The public space should reflect the desires and needs of its users by creating welcoming, sociable, walkable environments.

The public space should be designed to respond to the needs and values of its users by creating people centric places that are walkable, well connected and comfortable to linger in. The public and private built environment should be designed with consideration of its quality, amenity, connectivity and functionality. New housing should facilitate social and environmental connection, through the integration of high quality communal and public / private open spaces.

DESIGN GUIDANCE

Refer to the corresponding chapters and themes across both the Urban Design Guide and Housing Design Guide for guidance around Public Spaces and Amenity.

5.1 COMMUNAL OPEN SPACE

Cross block links

- i. UDG:
 - **4.6I** On site access
 - **4.6J** Green accessways on lots
 - **6.1A** Block permeability
- ii. HDG:
 - **3.4E** Cross-block connections
 - **3.4F** Laneways
 - **3.4G** Arcades/interior connections

Privately owned public spaces

- iii. HDG:
 - **3.4A** POPS general
 - **3.4B** Parks and plazas
 - **3.4C** Forecourts
 - **3.4D** Landscape setbacks
 - **3.4H** Courtyards
 - **6.1B** Size and location
 - **6.1C** Integrated landscaping

5.2 PRIVATE OPEN SPACE

Amenity

- i. UDG:
 - **6.1C** Orientation
 - **6.1D** Overshadowing
- ii. HDG:
 - **3.1A** Solar orientation
 - **3.1D** Privacy and outlook
 - **6.4A** Private open space and balconies
 - **6.4B** Connections

5.3 QUALITY PUBLIC SPACE

Green infrastructure

- i. UDG:
 - **5.4A** Street planting and canopy
 - **5.3A** Boosting tree canopy and coverage
 - **5.3B** Local planting and vegetation species
- ii. HDG:
 - **3.4D** Landscaped setbacks
 - **7.3A** Deep soil planting and tree canopy cover
 - **7.3B** Integrated green infrastructure

Furniture and materials

- iii. UDG:
 - **5.6A** Urban furniture
 - **5.6B** Public spaces and places material treatment

5.4 DIVERSE USERS AND AMENITIES

Inclusivity

- i. UDG:
 - **5.5A** Crime Prevention Through Environmental Design (CPTED)
 - **5.5B** Inclusive design elements
 - **5.5C** Gender sensitive urban design principles
 - **5.5E** Lighting

Amenities

- ii. UDG:
 - **5.2A** Flexibility, adaptability and activation capacity
 - **5.2B** Responsive design and programming
 - **5.2C** Pedestrian comfort, urban amenities and conveniences
 - **5.5D** Legibility and wayfinding



Location: Dockside Kingston,
Kingston Foreshore ACT.
Design: Stewart Architecture



BUILT FORM AND BUILDING DESIGN

Design high quality housing to meet the needs of residents and catering for diversity in housing choice.

High-quality housing should be designed to meet the growing needs of residents, while catering for a diversity in housing choice, living arrangements, stages of life and working life. Higher density living equals more amenity for residents, enhancing liveability and access to open space, transport opportunities and activity. Attractive and well-designed buildings bolster and strengthen a sense of community and ownership that has a positive impact on the broader streetscape and precinct.

DESIGN ELEMENTS

6.1 COMMUNAL OPEN SPACE

- 6.1A Activities and uses
- 6.1B Size and location
- 6.1C Integrated landscaping

6.2 COMMON CIRCULATION

- 6.2A Common circulation and spaces

6.3 DIVERSE HOUSING CHOICES

- 6.3A Types of housing
- 6.3B Apartment size and layout
- 6.3C Ceiling heights
- 6.3D Complementary uses
- 6.3E Housing accessibility

6.4 PRIVATE OPEN SPACE

- 6.4A Private open space and balconies
- 6.4B Connections

6.5 STORAGE

- 6.5A Within dwellings
- 6.5B Bulky items

6.6 DESIGN PERFORMANCE

- 6.6A Solar and daylight access
- 6.6B Shading
- 6.6C Thermal performance
- 6.6D Natural ventilation
- 6.6E Noise and acoustic comfort
- 6.6F Visual amenity



6

Location: Kingsborough
Development.

6.1 COMMUNAL OPEN SPACE

Provide generous and high quality communal open spaces to boost the amenity and liveability of communal living.

Communal space in apartments is equally as important as private open space. It provides a variety of benefits for residents and contributes to a sense of community within the building. Communal spaces boost the amenity, diversity, inclusivity and liveability of higher density urban living. They promote social interactions by creating shared spaces where residents can get to know each other.

DESIGN GUIDANCE

6.1A ACTIVITIES AND USES

- i. Encourage a diversity of residents by providing a mixture of communal uses suited to a wide range of people to help create more mixed and vibrant communities.
- ii. Provide activities and uses that appeal to people of all ages, genders and abilities and foster social interaction and connection between residents.
- iii. Provide pet friendly communal spaces on site.
- iv. Complement the private dwelling open spaces with shared communal spaces designed to provide high levels of amenity for all residents such as courtyards, roof tops, herb gardens, exercise areas and lawns.
- v. Consider providing communal amenity spaces such as party/dining rooms with large kitchens, libraries, cinemas, music rooms, games rooms, meeting rooms, working spaces, gyms and teaching spaces to provide something for all residents.
- vi. Design communal spaces that can be used in different weather conditions throughout the year.

- iv. Incorporate integrated landscaping into communal open spaces. This can be located separately to deep soil planting if necessary to enable greater flexibility with location.
- v. Enable the integration of deep-rooted landscaping and easy connection to the street and public areas from the ground area.
- vi. Where appropriate, provide gardens or rooftop gardens to accommodate more greenspace in the urban environment, increase the aesthetics of the buildings and support physical and mental health.
- vii. Where landscaping is proposed in rooftop gardens, design with the long-term consideration of delivery, maintenance and performance.

Tip: Open space sizes and location

The success of communal spaces starts with the right location and size to allow the desired activities to unfold comfortably. Consider the following:

- i. Appropriately sized to reflect the numbers of dwellings that will access and use the open space.
- ii. Located near circulation areas and entries to create easy access and incidental meetings between neighbours.
- iii. Receives sunlight throughout the whole year.
- iv. Dimensions are appropriate for the desired use and function and a minimum 6 m in any direction.

6.1B SIZE AND LOCATION

- i. **Ensure new housing development is consistent with common circulation and spaces requirements as they have elevated weighting.**
- ii. Include communal open areas in locations that optimise their potential to be used as intended and are easy to access for all inhabitants.
- iii. Locate communal open space where it is directly accessible from common entries and pathways and has a high degree of visual connection; this will increase the likelihood of use and incidental meetings between inhabitants.

Related planning strategies and tools:

- i. Refer to Planning specifications ZS1, ZS2 and ZS4.

Exemplar:

Kingsborough is an emerging precinct that offers generous communal space with shared gardens and a village square. These spaces support community engagement, creativity and sustainability.

Photo 17:
Kingsborough Village,
Kingston ACT. Developer: John
Gasson



6.1C INTEGRATED LANDSCAPING

- i. Provide landscaping within communal open spaces to provide comfort while animating and softening the space.
- ii. Use landscaping to provide privacy and amenity between communal and private areas.
- iii. Reduce heat island effect by integrating landscaping with communal spaces.
- iv. Locate mature and large trees in communal open spaces for easier maintenance and to allow residents to enjoy the benefits of shade and connection to nature that may not be possible in private spaces.
- v. Use communal areas for environmental opportunities such as urban agriculture, habitat biodiversity, improved water cycle and reducing stormwater runoff.

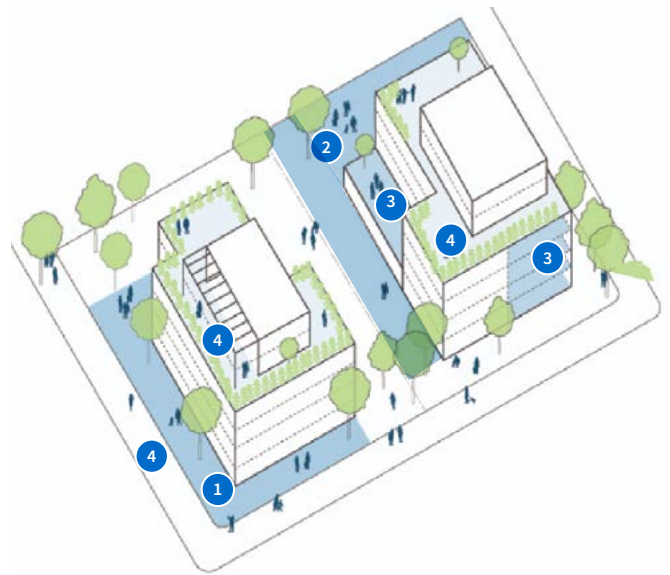

Figure 12: A wide range of communal spaces can be provided to support the diverse needs of residents while inviting neighbours to interact and form community.

Tip: Locate communal open spaces close to or with visual connection to circulation spaces whenever possible to increase the likelihood of use and incidental meetings between neighbours. Providing facilities for multiple activities in any given communal space increases the frequency of use, vibrancy and invitation for neighbours to connect.

- 1 FRONT SETBACKS**
Front setbacks can create an attractive public - private transition.
- 2 SHARED COURTYARDS**
Opportunity for communal gardens, function lawns, play areas and community interaction.
- 3 TERRACE AND BALCONIES**
Opportunity for community interaction and recreation, with views and outlook.
- 4 ROOFTOP GARDENS**
Opportunity for communal gardens, pool, recreation meeting rooms and function space and play area.

6.2 COMMON CIRCULATION

Provide well designed common areas that facilitate incidental interactions that support a sense of community.

Common areas of circulation that are well designed will contribute to the overall aesthetic and liveability of the development. These common areas support the sense of community as places where neighbours meet and interact such as entry ways, internal corridors and external areas, in addition to communal open space.

DESIGN GUIDANCE

6.2A COMMON CIRCULATION AND SPACES

- i. **Ensure new housing development is consistent with common circulation and spaces requirements as they have elevated weighting.**
- ii. To reduce the sense of long and uninteresting circulation spaces, provide openings such as windows and doors, a series of foyers and places to sit in the circulation corridor.
- iii. Provide natural daylight and ventilation to internal circulation corridors to improve cross-ventilation.
- iv. Provide suitable clearance in front of lift doors to allow for circulation, furniture delivery and emergency access.
- v. Design fire staircases to encourage their use as primary access to dwellings on lower floors thus promoting active lifestyle and minimising reliance on lifts for vertical circulation.
- vi. Encourage interaction and sense of community by providing places to gather and meet such as seating areas in circulation spaces and corridors. These can also increase opportunities for incidental meetings of neighbours.

Why this is important:

Circulation corridors are a prominent part of the experience of living in an apartment building. They should be designed as thoughtfully as the apartments to ensure best overall experience for residents.

Related planning strategies and tools:

- i. Refer to Planning specifications ZS1, ZS2 and ZS4.

- vii. To optimise navigation and wayfinding and reduce the walking distance between front door and street entry, minimise the length of corridors and number of apartment openings.
- viii. Balance the amount of cores to apartments to avoid overcrowding and slow access, and to support a sense of ownership.
- ix. Consider locating circulation areas to be visible to the street to increase the passive surveillance of public space and contribute to façade activation.



Exemplar:

A beautifully designed staircase in a green courtyard is the main circulation space leading to apartments. It is a focal point for the residents, allowing for natural ventilation to dwellings and incidental meetings between neighbours.

Photo 18: Napier Street, Fitzroy, VIC. Architect: Freadman White. Photograph: Gavin Green



Exemplar:

Generous circulation spaces can act as an extension of the communal space and encourage neighbours to interact supporting the creation of community within a development. This example has generous open-air corridors inviting residents to use the areas immediately adjacent to their front door thus increasing the chances of incidental meetings with their neighbours.

Photo 19:
Park Life, Brunswick. Architect: Austin Maynard Architects. Photo: Tom Ross

6.3 DIVERSE HOUSING CHOICES

Provide different sizes and types of housing to encourage mixed neighbourhoods.

Providing different sizes and types of homes helps meet our housing needs while catering to people's needs at different stages of their lives. Communities can flourish when a choice of different housing types is located in the same precinct or neighbourhood. These mixed neighbourhoods also provide for better social integration and sense of community.

DESIGN GUIDANCE

6.3A TYPES OF HOUSING

- i. Provide a mix of housing typologies that support future needs of the community and provide housing choice and affordability to households of all shapes and sizes.
- ii. Within new apartment developments, provide a range of different apartment sizes to allow for greater flexibility of choice and affordability.
- iii. Include dual occupancy and/or attached housing for developments in a low-density context. These developments can be designed to mediate between low-density detached housing and medium-density apartment buildings.

Related planning strategies and tools:

- i. Refer to the Urban Design Guide Theme 3 – Responding to context.
- ii. ACT District Strategies 2023.

- iv. Use different types of housing to create articulation and a mixture of scale in building forms. Use the spaces between different buildings or housing types to provide private or communal open and landscape areas.

Tip: Guidance for all scales of buildings

While this document appears focused on medium and high-density housing, the guidelines can be easily applied to all multi-dwelling housing types including townhouses and dual occupancy developments.

Why this is important:

Our diverse population has diverse housing needs. Creating more choices within medium and high-density housing will help people find the right housing for their needs and help create vibrant and desirable neighbourhoods.



Exemplar:

A multi-residential development which provides a mix of housing options with apartments and townhouses, helping to create articulation of mass and form across the site.

Photo 20: Merri Green, Northcote VIC. Design: Chamberlain Architects



Figure 13: Residential block showing a diverse mix of housing typologies with a variety of apartment sizes and layouts.

6.3B APARTMENT SIZE AND LAYOUT

- i. **Ensure new housing development is consistent with apartment size and layout requirements as Apartment size and layout requirements have elevated weighting.**
- ii. Include a range of dwellings sizes in all new developments, ranging from studio apartments to larger family homes, to encourage a diverse mix of residents.
- iii. Design floor plates so all dwelling size types are mixed throughout the development. This will mean some smaller apartments can also enjoy the best outlook and view while some larger apartments can be more affordable due to less premium location.
- iv. Consider providing larger apartment units for families and allowing working from home space, multiple main bedrooms, secondary living spaces, at least one bath, wider service spaces and easily access to communal spaces.
- v. Consider providing a study space with access to daylight and natural ventilation and with a minimum width to support working from home or a flexible guest room.
- vi. Include some dwellings with larger rooms to suit residents with particular mobility, lifestyle or furnishing needs.
- vii. Include some compact 3–4-bedroom family-appropriate dwellings to improve affordability for families or larger households.



Exemplar: Two small houses built on one block to minimise their overall environmental footprint. The two dwellings share a garden and the garage space doubles as hobby and rumpus room as the need for car storage is reduced in the inner northern suburb.

Photo 21: Dual occupancy in O'Connor, ACT. Design: DNA Architects

Why this is important:

Well-considered and appropriate dwelling layouts, sizes and room dimensions are important elements to ensure the quality, desirability and longevity of multi-dwelling living.

Related planning strategies and tools:

- i. Refer to the Urban Design Guide Theme 3 - Responding to context
- ii. ACT District Strategies 2023
- iii. Refer to Planning specifications ZS1, ZS2 and ZS4.

6.3C CEILING HEIGHTS

- i. **Ensure new housing development is consistent with ceiling height requirements as they have elevated weighting.**
- ii. Maximise flexibility and future proofing in mixed use precincts by including taller floor to floor height for ground and first floors to accommodate different uses should requirements change.
- iii. Design above ground car parks with typical residential or commercial floor-to-floor heights to enable future adaptation for alternative uses.
- iv. Design ceiling heights so apartments have good access to daylight and natural ventilation.
- v. In lower-level apartments, consider greater height than the required minimum to allow for better access to daylight and natural ventilation.
- vi. Provide sufficient ceiling heights that create high quality spatial experiences, enable flexibility of use and allow sufficient daylight to enter a dwelling.



Figure 14: Determine ceiling heights in consideration of the depth and function of the space.

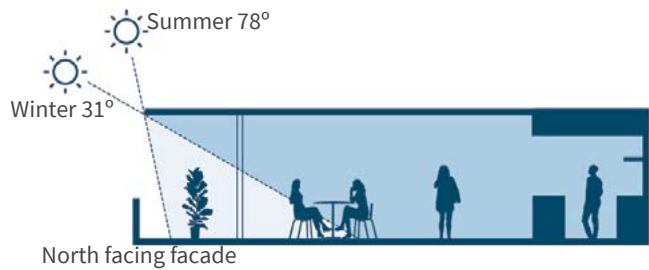

Figure 15: Design apartments with appropriate ceiling heights to ensure good access to daylight.

Related planning strategies and tools:

- i. Refer to Planning specifications ZS1, ZS2 and ZS4.

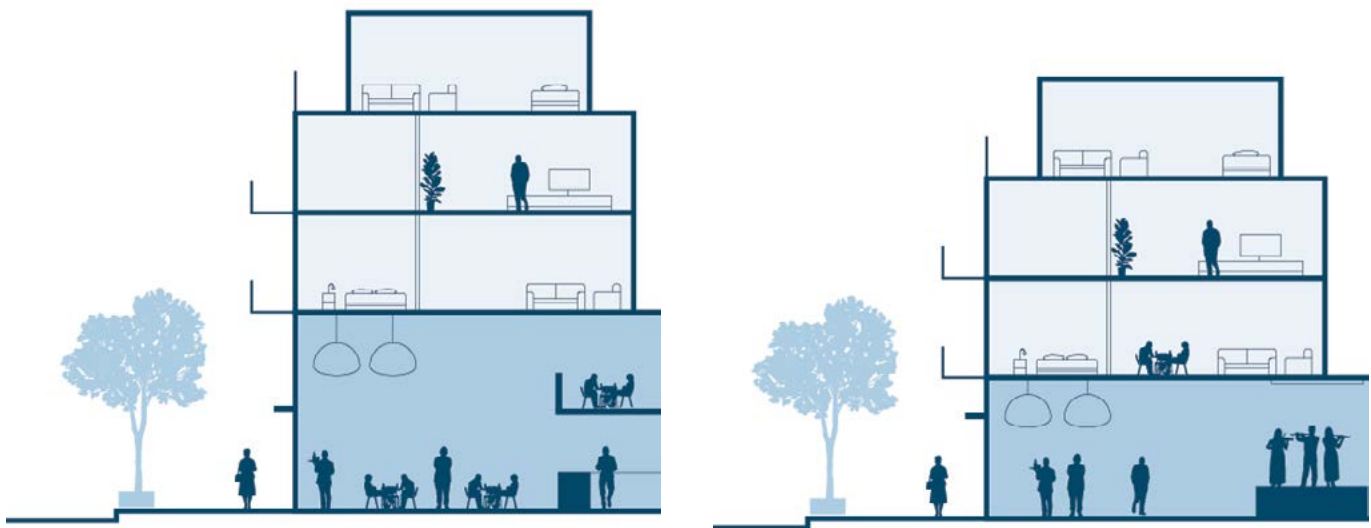

Figure 16: Design ground floor ceiling heights to be taller than typical floor levels to promote flexibility and adaptability of use.

6.3D COMPLEMENTARY USES

- i. Include non-residential uses within larger developments or developments located in mixed use zones, to improve activation across all times of the day and night.
- ii. Ensure that non-residential uses complement and enrich desirable housing, and don't create significant noise, air or visual pollution.
- iii. Locate non-residential uses on the ground floor to provide activation and passive surveillance of streets and other public areas.

Tip: Non-commercial ground floor uses:

Not all settings are appropriate for commercial and busy retail ground floor uses.

Other possible uses could be:

- family home with direct access to front garden or special needs home with improved accessibility
- office and co-workspace with independent street entrance
- workshop with neighbourhood tools, shared community amenity, shared laundry
- childcare, healthcare, fitness, salon
- Showroom/gallery, specialist shops, artist studio

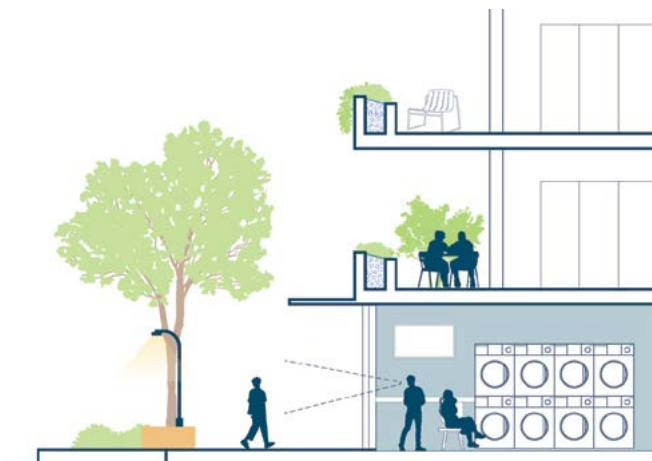

Figure 17: Locate complimentary uses on ground floor to provide passive surveillance, local amenity, and active frontage.

6.3E HOUSING ACCESSIBILITY

- i. Design new developments to be accessible to people of all ages and abilities, to promote inclusivity and attract more diverse residents.
- ii. Apply Universal Design principles to a percentage of dwellings in all larger developments.
- iii. Provide generous clearances in corridors, kitchens, laundries and bathrooms, as well as providing for grab rails and stair adaptation to ensure varying levels of accessibility.
- iv. Locate larger dwellings within apartment buildings on lower levels with generous private open space and easy access to communal open areas to attract more families into apartment buildings.

Tip:

Liveable Housing Australia (LHA) provides guidance on detailed measures to ensure varying levels of accessibility. LHA Silver is a desirable minimum standard for new housing in the ACT and must be achieved in a minimum of 20% of dwellings in new development.

Related planning strategies and tools:

- i. Comply with liveable housing requirements of National Construction Code.
- ii. Consider AS4299 for some dwellings.

6.4 PRIVATE OPEN SPACE

Provide people with private open spaces that connect them to landscape and natural surroundings to improve quality of life.

Private open space and connecting nature to the home is important for the health and wellbeing of residents, as well as their quality of life. A sense of privacy and outdoor living makes apartments more desirable to potential buyers or renters. Good design can create great private open spaces in higher density environments. Designers and developers should carefully consider incorporating private open spaces in housing designs to create more liveable and sustainable communities.

DESIGN GUIDANCE

6.4A PRIVATE OPEN SPACE AND BALCONIES

- i. **Ensure new housing development is consistent with private open space and balcony requirements as they have elevated weighting.**
- ii. Consider the size and arrangement of private open spaces so practical needs can be met within the proposed spaces, such as outdoor dining, barbecuing, drying clothes and growing plants.
- iii. Locate private open space adjacent to main living areas and habitable rooms where possible to maximise ease of access and use.
- iv. Consider service uses such as appropriate location of air conditioning condensers, outdoor clothes drying and washing of outdoor items with regards to size and arrangement of private open space.
- v. Consider acoustic separation between neighbouring courtyards or balconies to allow for privacy.
- vi. Consider micro-climate in the design of private open spaces to maximise their usable period throughout the year, for example a balcony open on three sides will be a lot more exposed compared to a balcony recessed behind the main building façade line.
- vii. Minimise overlooking to and from neighbours to provide privacy to open space and balconies.
- viii. Consider including a weatherproof power outlet and hose tap on all balconies and outdoor areas.
- ix. Avoid primary private open space orientation to the south unless compensated with partial direct sunlight, or a high-quality view such as public park, square or nature area.
- x. Locate primary private open space on the ground floor of multi-storey dwellings where possible to maximise ease of access and ground floor activation.

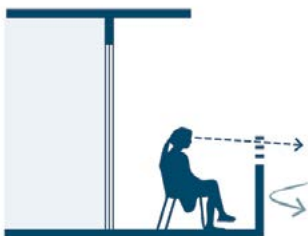

Some transparency of balustrades can allow inhabitants to also enjoy the view when sitting down.

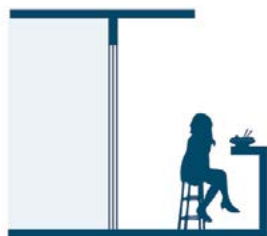

The balustrade can be designed to include usable furniture such as table or seating on narrow balconies.

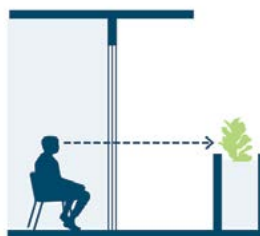

Integrated planters on balustrades can increase visual amenity from the dwelling and mitigate overlooking issues to neighbouring private open space.



Semi-inset balconies allow for greater weather protection against wind thus extending the useable season.

Figure 18: Types of balconies



Exemplar:

A mix of one to three-bedroom apartments with generous balconies and access to private outdoor green spaces.

Photo 22:

Dominion Residence, Forrest ACT. Architect: Collins Pennington. Photograph: Collins Pennington

6.4B CONNECTIONS

- i. Provide private outdoor space with clear connections to the natural environment and surrounding context of the suburb.
- ii. Include planters, lawns and gardens wherever possible, even in upper storey apartment balconies.
- iii. Allow for views of the sky and, where possible, surrounding vegetation, landforms and landmarks.
- iv. Provide amenity and indoor / outdoor lifestyle so residents can take advantage of ACT’s cold temperate climate.

Why this is important:

High quality private open space is a key ingredient in creating desirable and sought-after higher density housing options. Private open space is an important feature for apartments, providing a variety of benefits that contribute to the health, wellbeing, and quality of life of residents.



Small: Studio and 1-bedroom dwellings should allow for two comfortable seating spaces.

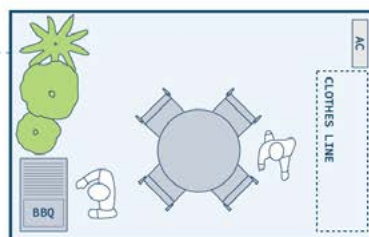

Medium: 2-bedroom dwellings should allow for a 4-person table, BBQ, clothes drying area and planting.

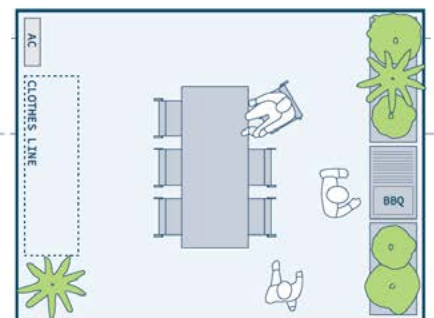

Large: 3+ bedroom dwellings should allow for a 6-person table, lounge, BBQ, clothes drying area and planting.

Figure 19: Design solutions for protected balconies. Noisy locations may require different solutions such as enclosed wintergardens, balconies with operable walls, or Juliet balconies.

6.5 STORAGE

Provide generous storage areas to maximise usability of living spaces in higher density living.

Adequate storage is important. Storage maximises living space, which is particularly important for higher density living where apartments are often small. Storage also provides convenience, compliance and added value, allowing residents to live comfortably and support a diversity of households.

DESIGN GUIDANCE

6.5A WITHIN DWELLINGS

- i. Provide wardrobes, linen and broom cupboards as essential elements of liveable housing at practical sizes for all dwelling types.
- ii. Consider the needs of residents and provide appropriate storage for household goods in kitchens and laundries.
- iii. Use the height of rooms for elevated storage above wardrobes for such things as blankets, suitcases and seasonal items. This minimises floor area impact of practical storage.
- iv. Consider locating at least 50% of the required storage within the apartment, accessed from either circulation or living areas.

Why this is important:

Convenient storage is often one of the main challenges to overcome in the perceived desirability of apartment living. Adequate storage for activity-based equipment such as bicycles, golf clubs or kayaks encourages active lifestyles and improves resident wellbeing.

Related planning strategies and tools:

- i. Refer to Planning specifications ZS1, ZS2 and ZS4.

6.5B BULKY ITEMS

- i. Provide enclosures within garages for additional storage of larger items where possible.
- ii. Allow for a convenient storage location outside of the main dwelling for bulky items and less frequently used equipment; this location should accommodate items of various shapes and sizes and be weatherproof, secure and allocated to specific dwellings.
- iii. Provide visual screening to storage enclosures for improved security and functionality.
- iv. Consider adding extra length to garage and car park areas to provide flexibility to residents about what and how to store items.
- v. Provide private storage of garden tools that is easily accessible from the garden area for dwellings with courtyards or lawns.
- vi. Provide integrated storage for bicycles and electric scooters.

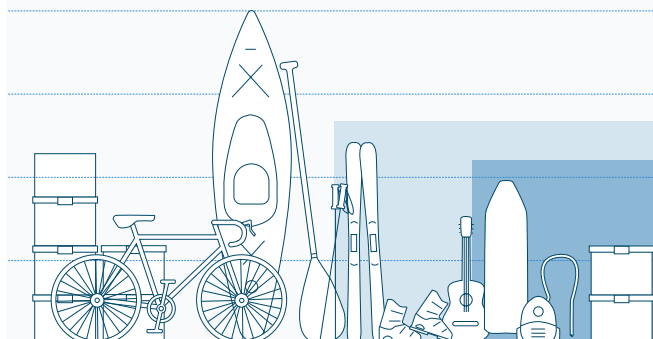

Figure 20: Suitable storage should be provided to meet the needs of residents and increase to reflect the size of the apartment.



Exemplar: Providing housing choice

Sensitive integration of multi-residential in a suburban location provides complementary dwelling types to detached houses with ground floor units with front gardens and different apartment types.

Photo 23: Synergy Apartments, Turner ACT. Architect: Ring and Associates

6.6 DESIGN PERFORMANCE

Create spaces that allow residents to access light, air, comfort and passive living conditions without compromising privacy.

Access to natural light is essential to support a healthy lifestyle, provide comfortable living conditions and reduce the energy demands for artificial lighting. Natural ventilation allows for the circulation and change of fresh air which contributes to thermal comfort, passive cooling opportunities and a comfortable and healthy indoor environment. Privacy and outlook impact the overall functionality, comfort, and liveability of a space.

DESIGN GUIDANCE

6.6A SOLAR AND DAYLIGHT ACCESS

- i. **Ensure new housing development is consistent with solar and daylight access requirements as they have elevated weighting.**
- ii. Orient living spaces and bedrooms towards the north wherever possible to allow for direct solar access in winter, with shaded glazing in summer.
- iii. Consider neighbouring building's access to sunlight and mitigate any negative impact on amenity where possible. This can be achieved by providing greater setbacks, recesses or modulating the built form to respond to the location of adjacent windows or areas of private outdoor space.
- iv. Provide adjustable screens, windows, awnings and balconies to offer a sense of sheltered openness and connection to nature while providing maximum comfort and protection from the elements – sun, rain, cold and wind.
- v. Use horizontal shading elements on northern facing elevations and vertical or adjustable elements to the east and west facing elevations to temper direct sunlight throughout the day.
- vi. Provide high quality landscaping and deep planting with large canopy trees to provide shade, reduce urban heat island effects, improve amenity and reinforce the character of the area.
- vii. Increase the height of windows for deeper floor plates to allow more daylight into dwellings.
- viii. Avoid long thin recesses to windows to minimise shadowed areas that reduce access to daylight.
- ix. Provide all habitable rooms with openable windows with sufficient area of glazing to allow for quality of light and ventilation.
- x. Provide appropriate depth of room in relation to ceiling height or primary window (whichever is higher) to allow sufficient daylight to reach habitable rooms and living areas. This excludes room depths occupied by storage space or non-habitable areas.
- xi. Enable as many dwellings as possible have access to direct sunlight in habitable rooms throughout the day and year.

Why this is important:

Harnessing the qualities of the natural environment and positive aspects of weather increases wellbeing and reduces reliance on artificial climate controls.

Related planning strategies and tools:

- i. Refer to Planning specifications ZS1, ZS2 and ZS4.

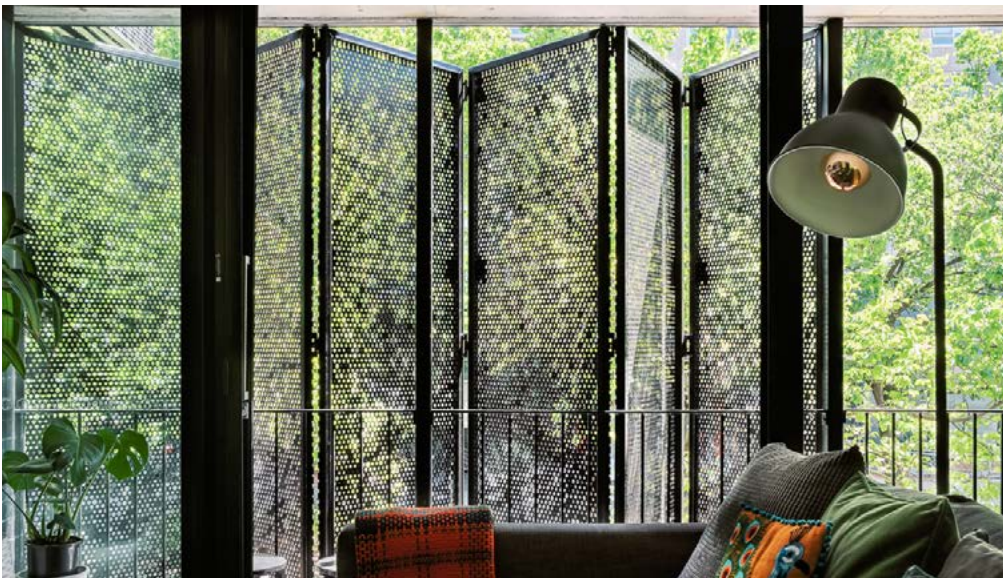

Exemplar: Operable screens and shutters

The use of operable shading elements allows for flexibility in filtering light, air, wind, privacy and sounds between inside and out.

Photo 24:

Church on Napier, Collingwood, VIC. Design: Kerstin Thompson Architects. Photograph: Dylan James + Thurston Empsom

6.6B SHADING

- i. Provide solid shading elements/devices to block direct summer sun on elevations with high proportion of glazing to minimise unwanted heat gains. Performance glass is not an acceptable substitute for solid shading.
- ii. When including solid shading, ensure it does not limit access to winter sunlight.
- iii. Provide external and operable sun shading to private open space if oriented between north-west and south-west, to enable inhabitants to block unwanted summer sun.
- iv. Consider using architectural elements such as protruding balconies, lintels, columns and window recesses to create self-shading elements appropriate to the façade orientation to reduce unwanted heat gains from direct sunlight.

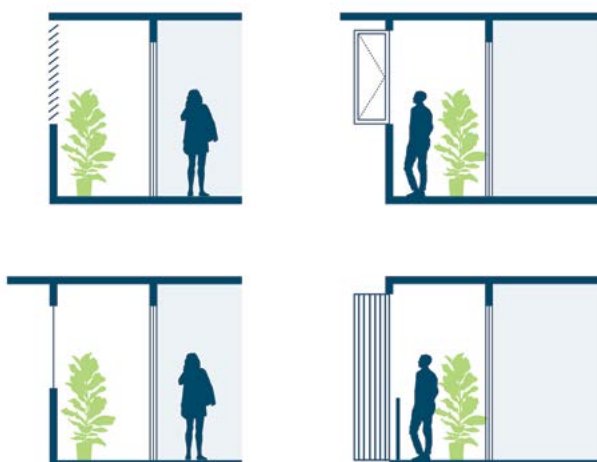

Figure 21: Adapting balconies to climatic conditions to extend the useable season of the private open space can include solutions such as vertical or horizontal shading, operable panels, awnings or enclosed wintergardens.

Related planning strategies and tools:

- i. Refer to Planning specifications ZS1, ZS2 and ZS4.

Why this is important:

Enabling inhabitants to operate and manipulate their dwelling to respond to the time of day and changes in weather and the external environment improves the quality of life and wellbeing of the inhabitant to ensure best overall experience for residents. For example, use screens, shades, shutters and windows.

6.6C THERMAL PERFORMANCE

- i. Minimise direct sunlight to the interior during summer to reduce energy required for cooling.
- ii. Allow direct sunlight access to the interior during winter to reduce energy required for heating.
- iii. Include heavier materials in floors and walls reached by direct sunlight in winter to create thermal mass that can store and release warmth after the sun sets.
- iv. Maximise thermal performance in buildings and dwellings to provide comfortable living conditions and reduce the energy demands for artificial lighting and heating/cooling.
- v. To maintain a comfortable living environment, locate balconies, windows and sun shading devices to capture sunlight through the winter, and temper sunlight in the summer.

6.6D NATURAL VENTILATION

- i. **Ensure new housing development is consistent with natural ventilation requirements as they have elevated weighting.**
- ii. Naturally cross ventilated apartments consider the direction of prevailing breezes and provide openings configured to draw air movement between different rooms from a windward to a leeward façade orientation.
- iii. Maximise the number of naturally cross ventilated apartments and rooms by good apartment planning that facilitates corner apartments or apartments that run between facades.
- iv. Provide natural cross ventilation between rooms for the benefit of the entire apartment. Ventilation between openings within a single room does not meet the definition of natural cross ventilation.
- v. Use high windows to open corridors to allow cross-ventilation without the loss of privacy or security.

Related planning strategies and tools:

- i. Refer to Planning specifications ZS1, ZS2 and ZS4.

- vi. Design buildings so windows can be left partially open during rainy weather to allow for maximum airflow and ventilation.
- vii. Comply with statutory requirements relating to fall risk.
- viii. Make sure enclosed balconies do not obstruct airflow to a degree that prevents natural ventilation within the dwelling.
- ix. Limit the depth of cross over or cross through apartments to ensure workable natural cross ventilation.

Why this is important:

Natural ventilation is cheaper than artificial ventilation like air-conditioning and saves unnecessary emissions and use of energy. Natural ventilation can change the indoor climate by moderating temperature, humidity, and smells. It helps minimise the risk from breathing dangerous particles and mould. It improves overall wellbeing by allowing inhabitants to improve their own environment and air quality.

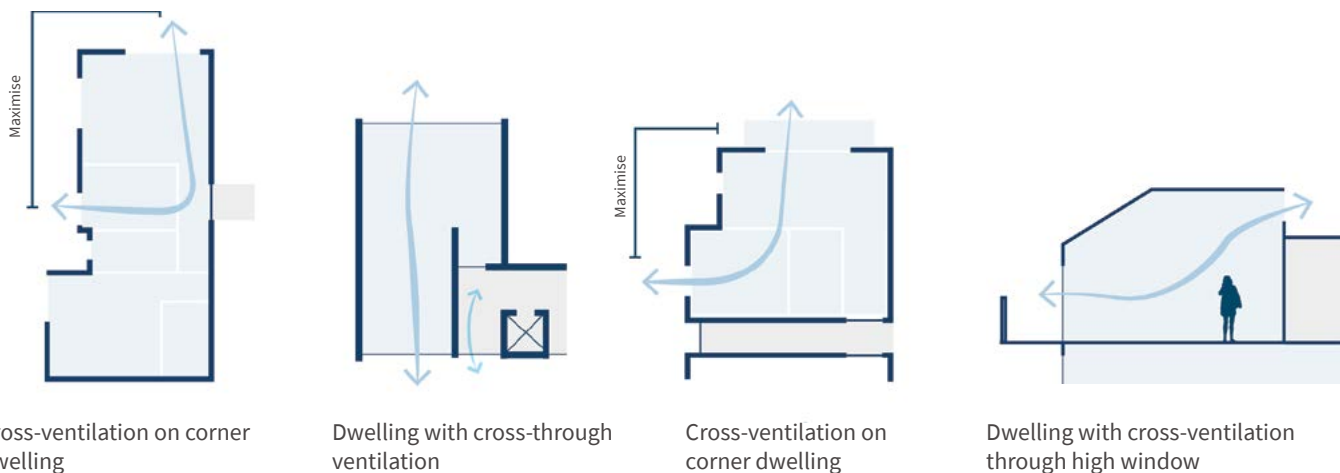
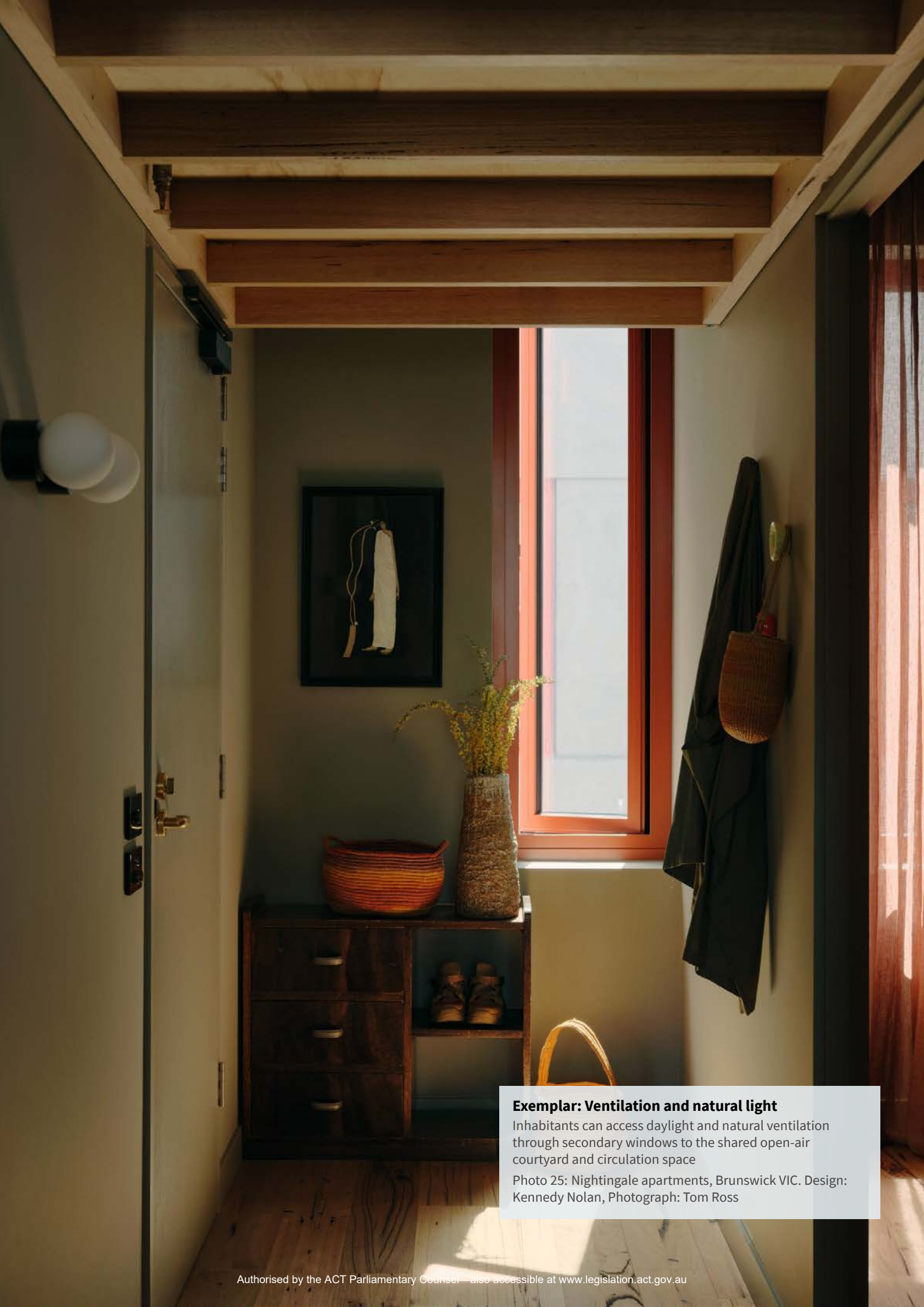

Figure 22: Examples of cross ventilation



Exemplar: Ventilation and natural light

Inhabitants can access daylight and natural ventilation through secondary windows to the shared open-air courtyard and circulation space

Photo 25: Nightingale apartments, Brunswick VIC. Design: Kennedy Nolan, Photograph: Tom Ross

6.6E NOISE AND ACOUSTIC COMFORT

- i. Minimise the impact of unwanted noise and vibrations to sensitive uses from surrounding noisy uses through consideration of site, location, materials and apartment layout.
- ii. Design party walls between adjacent attached housing or apartments to perform above minimum building code standards to reduce noise and low frequency noise impacts.
- iii. Provide a buffer such as office space or communal open space between residential uses and other noisier land uses such as events and entertainment.
- iv. Use wintergardens with noise reducing design for private outdoor space instead of open balconies in noisy locations.
- v. Block direct line of sight to the source of unwanted noise for courtyards where possible. This can still provide excellent connection to earth and sky without negative impact of noisy neighbours or context.
- vi. Locate and screen mechanical equipment that produces noise to minimise negative noise and visual impacts.
- vii. Ensure consideration and mitigation of adverse impacts of surrounding development and uses, including permitted uses within a development such as ground floor uses, in the design to protect residential amenity.

Related planning strategies and tools:

- i. Refer to Planning specifications ZS1, ZS2 and ZS4.

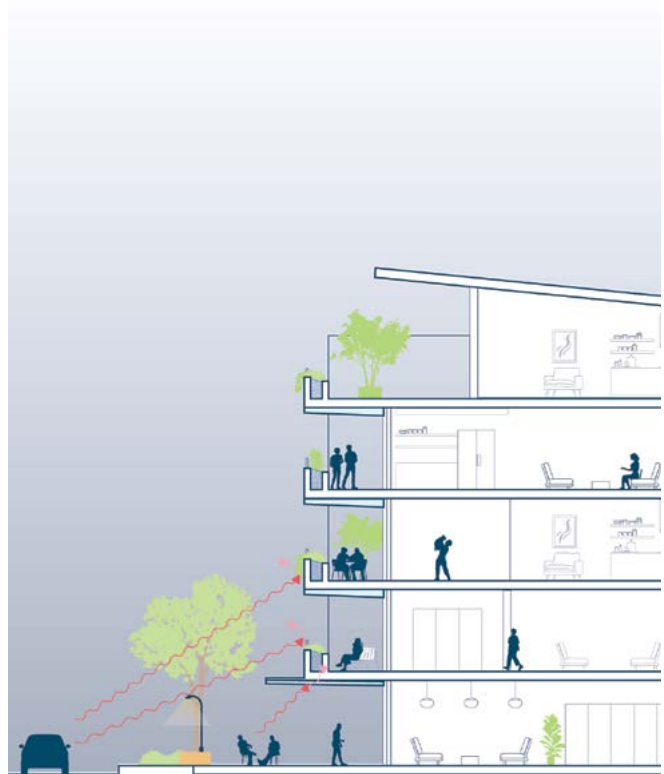

Figure 23: Balcony design can help reduce road and street noise as well as neighbours through soffit material choice, screening and planting while allowing for cross-ventilation and views.



Exemplar:

Enclosed external circulation area to apartments provides balcony spaces for inhabitants as well as reducing noise from the adjacent busy road.

Photo 26: Ørstad Gardens, Frederiksburg Denmark. Architect: Tegnestuen LOKAL, Photographer: Hampus Berndtson

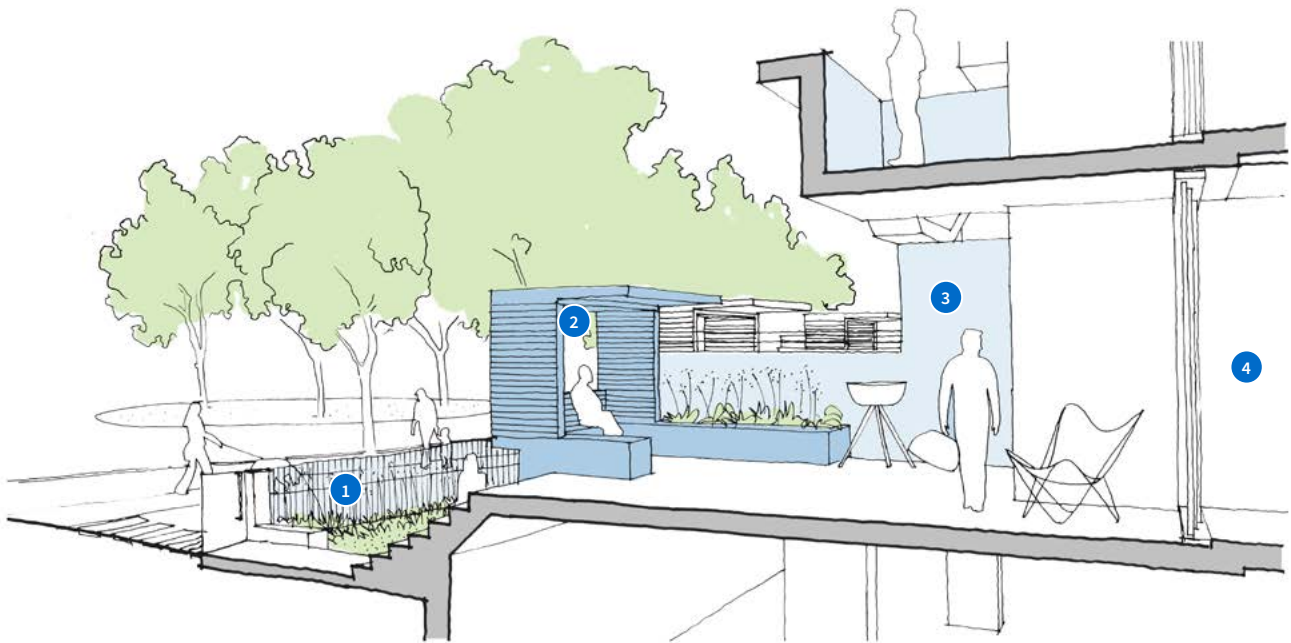

Figure 24: Filtering views, outlook and privacy

- | | | | |
|--|--|--|--|
| <p>1 <u>SCREENING AND SECURITY</u></p> <p>Provide privacy and screening with permeable fencing while allowing for surveillance.</p> | <p>2 <u>VISIBILITY</u></p> <p>Provide privacy and outlook through elevated courtyards, framed views and set back balconies.</p> | <p>3 <u>SEPARATION</u></p> <p>Provide separation and privacy between dwellings while still allowing for interaction with lower walls in strategic locations</p> | <p>4 <u>PRIVACY</u></p> <p>Ensure internal spaces are secure and private but well connected to activated edges.</p> |
|--|--|--|--|

6.6F VISUAL AMENITY

- i. **Ensure new housing development is consistent with visual privacy and building separation requirements as they have elevated weighting.**
- ii. Optimise outlook for dwellings by carefully considering their design, orientation, layout, and floor-to-ceiling heights.
- iii. Provide quality open space and well-designed windows and openings to connect new dwellings to place and the natural environment.
- iv. Enhance liveability and desirability of new developments by capturing key views to improve outlook and general wellbeing of residents.
- v. Provide flexible and operable screening to balconies and windows to mitigate privacy concerns where overlooking may occur.
- vi. Provide privacy and avoid overlooking without compromising outlook to key views and access to daylight, natural ventilation and open space.

Why this is important:

Privacy and outlook are important when it comes to residents and their homes. People want to feel safe and secure in their own space, and they want to be able to control who has access to it. Privacy can be achieved through thoughtful design that creates physical barriers between units, such as soundproof walls and entrances, as well as by providing control to natural light and visibility. Balancing privacy with outlook and the desire for views is important as good outlook can have a positive impact on the mental health and wellbeing of residents, while also adding value to the property.



SUSTAINABILITY AND ENVIRONMENT

Create healthy and sustainable environments that are resilient, adaptable and minimise resource consumption.

Providing healthy and sustainable environments for both natural systems and communities is an important function of any urban ecosystem. Modernising and repurposing existing assets to achieve better environmental outcomes should be a priority. New and existing developments should be designed to respond to the Canberra climate and should integrate sustainable building technologies. All buildings and public spaces should be designed for a long lifespan so their embodied energy is spread over a longer time, and must be adaptable, consume less energy, produce less waste and manage water responsibly.

DESIGN GUIDANCE

7.1 CLIMATE CHANGE RESILIENCE

- 7.1A** Flood resilience
- 7.1B** Bushfire resilience
- 7.1C** Heatwave and urban heat island resilience

7.4 FLEXIBLE, ROBUST AND FUTURE-PROOFED

- 7.4A** Robust, low maintenance materials
- 7.4B** Flexibility, adaptability and future proofing

7.2 RESOURCE CAPTURE AND MANAGEMENT

- 7.2A** Rainwater capture and reuse
- 7.2B** Energy capture and management
- 7.2C** Electrification and energy efficiency
- 7.2D** Local food production

7.5 SOCIAL RESILIENCE

- 7.5A** Affordability and economic diversity
- 7.5B** Sense of community and cohesion
- 7.5C** Safety and security

7.3 INTEGRATED LANDSCAPE PLANTING

- 7.3A** Deep soil planting and tree canopy cover
- 7.3B** Integrated green infrastructure

7.6 GOVERNANCE MODELS AND PROCESSES

- 7.6A** Procurement, construction, upcycling and embodied carbon
- 7.6B** Waste management



Illura residence.
Design: Ellenberg Fraser
Architecture

7.1 CLIMATE CHANGE RESILIENCE

Prepare for climate instability by designing dwellings to withstand extreme weather events such as floods, droughts, bushfires and heatwaves.

Incorporating climate change resilience into the design of housing creates sustainable and liveable communities. With the impacts of climate change becoming more severe and frequent, homes must be able to withstand extreme weather events such as floods, droughts, bushfires and heatwaves. Building resilience into housing can also reduce the environmental impact of homes and lower energy costs, while ensuring that homes are able to serve as a long-term investment for homeowners.

DESIGN GUIDANCE

7.1A FLOOD RESILIENCE

- i. Design buildings with elevated habitable areas and foundations, using elements such as stilts or piers to help keep living spaces above projected flood zones.
- ii. Use flood resistant materials for exterior walls, such as brick or stone, that can help reduce the risk of permanent flood damage.
- iii. Incorporate flood vents or other flood openings to help allow water to flow through the building's lower levels without causing significant permanent damage.
- iv. Detail facades with multiple, physical fail-safes to prevent water ingress.
- v. Incorporate waterproof coatings and sealants to vulnerable exterior roofs, walls and foundations to prevent staining of surfaces.
- vi. Elevate electrical utilities and HVAC systems above projected flood levels to prevent damage to critical systems infrastructure during a flood.
- vii. Install high-capacity drainage systems such as gutters and downpipes to divert water away from the building and reduce the risk of flooding during a heavy rain event.
- viii. Maximise block permeability through use of permeable surface paving to reduce the impact of flood and water run-off.

7.1B BUSHFIRE RESILIENCE

- i. All development in the bushfire prone area must comply with the ACT Bushfire Management Standards.
- ii. Locate new housing in areas that are less vulnerable to bushfires, such as those with lower fuel loads to reduce the potential risk to life, infrastructure and property.
- iii. Create defensible space around the building by clearing vegetation, maintaining a well-watered lawn, and placing fire-resistant plants around the perimeter to reduce the risk of bushfire damage.
- iv. Incorporate fire-resistant materials in the roof, walls, and other exterior elements of the building, such as brick, stone and metal, to reduce the risk of ignition.
- v. Avoid combustible exterior cladding materials like timber and opt for non-combustible materials such as steel or cementitious product to reduce the risk of ignition.
- vi. Incorporate ember-resistant design features such as ember guards, gutter guards. Sealing gaps and openings can help prevent embers enter the building.
- vii. Incorporate fire-resistant glazing and frames for windows and doors to reduce the risk of fire penetration.
- viii. Ensure buildings are accessible by emergency services to allow more efficient response in the event of an emergency.
- ix. Provide appropriate fire suppression systems, such as sprinklers or water mist systems, to help suppress fires and limit their spread.
- x. Equip buildings with sufficient early warning systems, such as smoke detectors and sirens, to alert occupants to the presence of smoke or fire and allow efficient evacuation.



HEATWAVES

Will become hotter, more frequent and last longer.



DROUGHTS

Will increase in severity and frequency.



STORMS

Will become more intense, causing flash flooding.



BUSHFIRES

Will become more dangerous.

Figure 25: Changing climate

7.1C HEATWAVE AND URBAN HEAT ISLAND RESILIENCE

- i. Incorporate passive cooling design features, such as natural ventilation, shading elements and thermal massing to help reduce the need for mechanical air conditioning.
- ii. Use local endemic and drought tolerant plants species to reduce water consumption and plant maintenance costs.
- iii. Design for passive irrigation where runoff from hard surfaces is directed into vegetation to maximise cooling effects and mitigate against run-off.
- iv. Use high quality insulation in walls, roofs and windows to help reduce heat transfer from the exterior environment, keeping the interior of the building cooler and reducing the need for mechanical air conditioning.
- v. Use cool or reflective roof materials, such as white or light-coloured roofing, to help reduce the heat gain from the sun and keep the building interior cool.
- vi. Incorporate shading devices into the façade elements, such as awnings, to prevent heat gain, restricting it to the building exterior and keeping the building interior cool.

Changing climate causes increases in extreme weather events in the future. The ACT Government is committed to ensuring Canberra adapts to the changing climate so that it can remain a vibrant, resilient and liveable city.

ACT Climate Change Strategy 2019-2025

Related planning strategies and tools:

- i. ACT Climate Change Strategy 2019-2025
- ii. ACT Government City Renewal Authority Sustainability Strategy 2021-2025 (applies to Dickson, Braddon, Civic, Northbourne Avenue, Haig Park and West Basin, but offers information relevant for the whole of the ACT)
- iii. Canberra’s Living Infrastructure Plan: Cooling the city
- iv. ACT Wellbeing Framework 2020
- v. ACT Regional Fire Management Plan 2019-2028
- vi. ACT Strategic Bushfire Management Plan and Standards
- vii. ACT Flood Sub-Plan 2023

Tip: Climate modeling

The ACT is included in the NSW Government’s NARCLiM regional climate modeling. The ACT Government recommends you use NARCLiM when considering the ACT’s future climate in engineering, urban design and planning projects.

7.2 RESOURCE CAPTURE AND MANAGEMENT

Design to reduce dependence on energy and resources for sustainability and resilience.

The sustainable capture and management of resources such as water and energy reduce a building's dependence on external sources of water, thus lowering ongoing costs and reducing the strain on municipal systems. It can promote conservation and reduce wasteful emissions, while improving the overall sustainability and resilience of the community.

DESIGN GUIDANCE

7.2A RAINWATER CAPTURE AND REUSE

- i. Incorporate green and blue roof strategies that capture, store and reuse rainwater for use in landscape irrigation and other appropriate uses, reducing water consumption and improving urban resilience to droughts.
- ii. Ensure that rainwater management processes and infrastructure comply with the ACT Government Water Sensitive Urban Design (WSUD) code to align with the ACT's broader requirements and best practice standards for rainwater management.
- iii. Configure rainwater tank capacity to respond to contextual weather conditions and provide sufficient on-site irrigation for foreseeable periods without rain to reduce reliance on potable mains water.
- iv. Incorporate rainwater reuse into ancillary functions that do not require potable water such as toilets and washing machines to reduce water consumption. Use grey water to supplement irrigation of landscaped areas and treat it in bio-sensitive ways before discharging from a development site.
- v. Embed permeable surfaces in rooftops, podiums and adjacent hardscapes that filter water to rainwater tanks in accordance with ACT Government Living Infrastructure Plan targets to maximise the rainwater capture capacity of new development, while improving natural irrigation outcomes and reducing flood risk.
- vi. Equip all new dwellings with water-efficient fixtures and fittings, such as low-flow toilets, showerheads, and faucets to reduce water consumption.
- vii. Where appropriate, provide rain barrels at each dwelling to capture rainwater for individual use, such as watering plants or cleaning.

7.2B ENERGY CAPTURE AND MANAGEMENT

- i. Explore opportunities to embed renewable energy capture infrastructure such as photovoltaic panels on rooftops and spaces that are not allocated for communal use, to maximise local energy production and reduce the dwellings' carbon footprint, reliance on municipal infrastructure and ongoing operating costs.
- ii. In typologies where each dwelling has its own rooftop, connect solar panels to each individual dwelling's power meter to enable greater flexibility and discretion in utilising solar power.
- iii. Orient solar panels to maximise efficiency while mitigating any negative impact on neighbouring development or public spaces via glare.
- iv. Explore opportunities to embed battery storage infrastructure to maximise benefit of renewable power generation and improve resilience and redundant capacity. Battery storage infrastructure must consider bushfire resilience and relevant approval requirements.
- v. Where battery storage is incorporated, establish energy demand management systems, including grid-integrated battery storage, to allow batteries to feed excess energy back into the grid.
- vi. New development should use zero emissions energy sources, have no connection to the natural gas distribution network and, where possible, use all-electric systems and appliances.

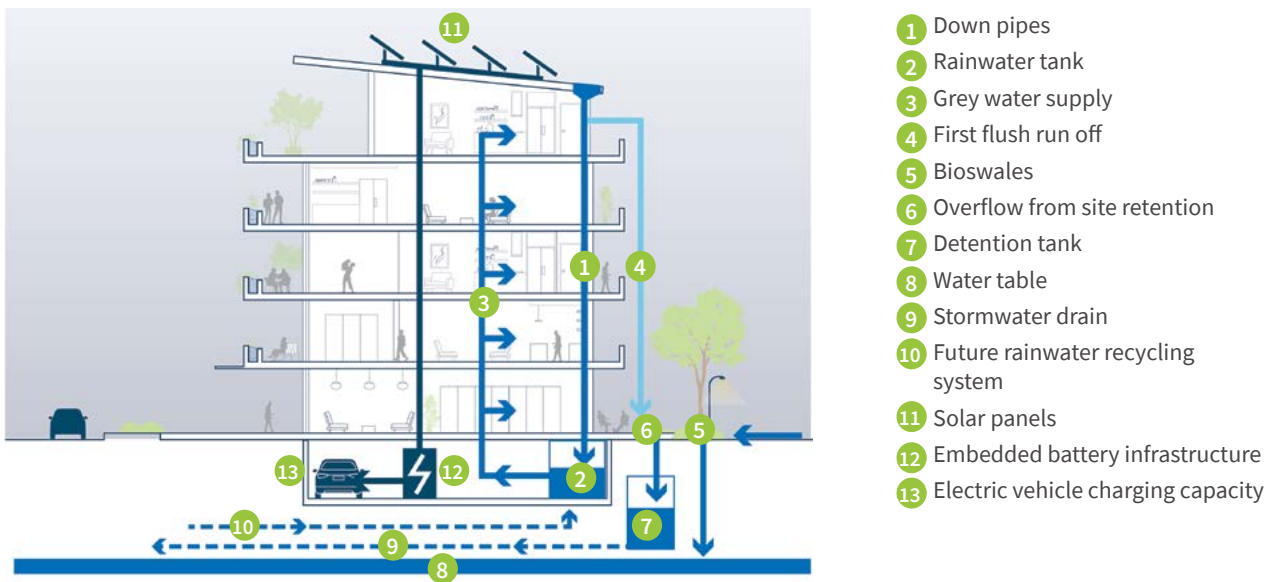

Figure 26: Water and energy capture and management

7.2C ELECTRIFICATION AND ENERGY EFFICIENCY

- i. Enable all dwellings with zero emissions energy sources, requiring no connection to the natural gas distribution network and using all-electric systems and appliances such as induction cook-tops to maximise electrification and reduce emissions. (Refer to ACT Pathway to Electrification)
- ii. Install energy-efficient lighting systems and appliances, including LED lighting, smart thermostats, and Energy Star-rated appliances to reduce energy consumption and emissions.
- iii. Incorporate natural lighting and ventilation where possible to reduce the need for artificial lighting and air conditioning.
- iv. Use energy efficient windows and insulation to reduce heating and cooling energy consumption and emissions.
- v. Plan to accommodate the space requirements needed for sustainable electric equipment (heat pump, storage tanks, chillers, air handling units, etc.) to ensure successful integration into building design and provision for future technology.
- vi. Incorporate centralised building automation systems to optimise energy usage by digitising the control of lighting, heating and cooling energy consumption.
- vii. Use high efficiency HVAC systems with appropriate sizing and zoning to reduce energy consumption.
- viii. Provide Electric Vehicle (EV) charging infrastructure capacity to embed future capability to accommodate EVs across new development and reduce emissions.
- ix. Design and placement of battery storage must consider bushfire resilience.
- x. Incorporate secure cycle parking to encourage active travel and minimise fossil fuel emissions.

7.2D LOCAL FOOD PRODUCTION

- i. Where appropriate, incorporate community gardens that allow residents to grow their own food, reduce emissions and waste.
- ii. Provide shared facilities that enable the sharing of resources for food production, such as tools, seeds and processes, to reduce costs and promote communal cooperation.
- iii. Embed rainwater harvesting infrastructure that reduces the need for potable water to irrigate community gardens.
- iv. Embed composting facilities that provide nutrient-rich soil for community gardens and reduce the amount of waste sent to landfill.

Why this is important:

We know that food systems account for about one quarter of all human made greenhouse gas emissions, making what we eat a significant contributor to our carbon footprint. By making healthy food choices the easy and convenient choice, we positively impact the health and sustainability of our cities.

7.3 INTEGRATED LANDSCAPE PLANTING

Provide urban landscapes that reduce the heat island effect and make cool, comfortable, shaded environments.

Providing greenery and green space in urban environments unlocks an immense range of benefits for people. Urban greenery can improve the micro-climate through reducing the heat island effect and providing cool, comfortable shaded environments. Planting absorbs air pollutants, reduces noise levels and boosts the broader biodiversity of the surrounding area.

DESIGN GUIDANCE

7.3A DEEP SOIL PLANTING AND TREE CANOPY COVER

- i. Provide deep soil planting zones to maximise tree canopy coverage of larger, long-lived shade trees as per Living Infrastructure Plan targets.
- ii. Prioritise the retention of native trees, particularly mature/ hollow-bearing trees, and their ecological context (functional surroundings) across the urban landscape.
- iii. Complement tree plantings with a mix of native plant species in vertical layers, to add vegetation complexity and introduce habitats for biodiversity.
- iv. Maintain the presence and health of significant existing trees on the site to maintain existing canopy coverage and amenity and promote natural succession and age structures, while minimising the need for new shade trees to achieve canopy coverage objectives.
- v. Incorporate as much tree canopy cover as possible and as a minimum compliant with zone planning specifications to boost the presence of greenery and minimise urban heat island effects.

7.3B INTEGRATED GREEN INFRASTRUCTURE

- i. Explore opportunities to embed sustainable planting elements into the built form, such as rooftop gardens and walls, living façades, ground plane gardens and balcony planters that mitigate the urban heat island effect and facilitate green relief in the urban environment.
- ii. Explore opportunities to incorporate productive gardens and urban farming elements in communal areas and rooftops to improve urban resilience, reduce waste and foster opportunities for social connections between neighbours.
- iii. Where possible, incorporate elevated podium spaces embedded with greenery, ideally with a functional purpose to provide shade and cooling, beyond aesthetic improvement.
- iv. Where possible, incorporate planter beds capable of accommodating greenery visible from the street into all communal balconies and shared spaces with a street address.

Related planning strategies and tools:

- i. Canberra's Living Infrastructure Plan: Cooling the city
- ii. ACT Climate Change Strategy 2019-2025
- iii. Refer to the relevant district strategy
- iv. Refer to Planning specifications ZS1, ZS2 and ZS4.
- v. ACT Living Infrastructure Strategy
- vi. ACT Urban Forest Strategy
- vii. Strategic Bushfire Management Plan
- viii. ACT Bushfire Management Standards
- ix. Gawari Ngilanmanyin. Remembering the Bush. A Climate-wise Landscape Guide for the ACT

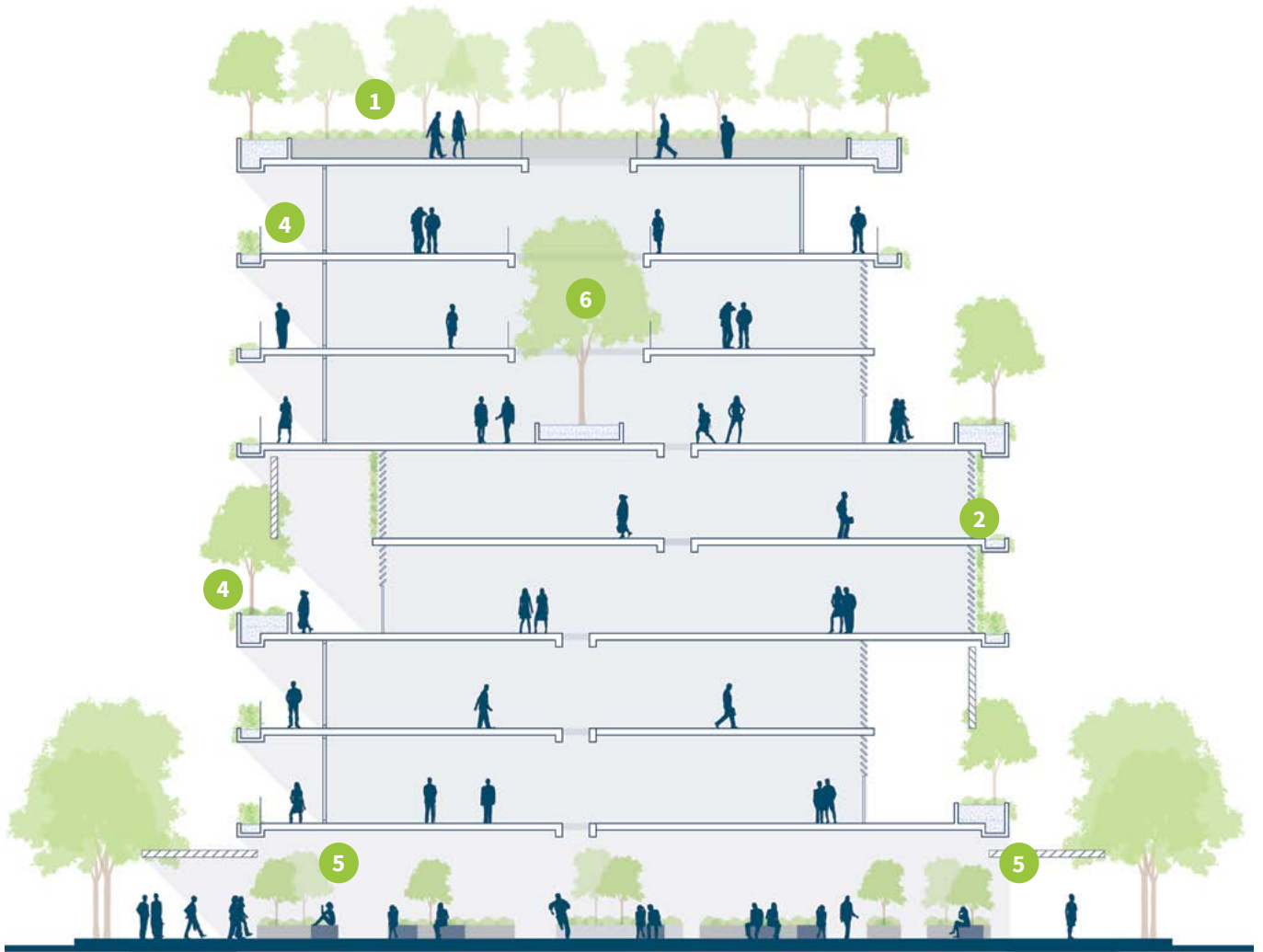

Figure 27: Integrated landscape planting

Why this is important:

Considered and integrated landscape treatments within built form that is substantial and capable of thriving can improve energy efficiency and air quality, create biodiversity and habitat, assist with stormwater management and improve building aesthetics as well as overall health and wellbeing of buildings and urban environments.

- 1 ROOFTOP GARDENS**
Rooftop gardens can be used for recreation spaces, urban farming, commercial functions such as a bar or restaurant or for biodiversity habitats such as beehives, and bird and bat boxes.
- 2 VERTICAL GARDENS**
Vertical greenery softens the urban environment through providing green amenity and relief.
- 3 FAÇADE PLANTING**
Building façades and massing can be articulated to unlock space for planting that adds place value and distinct character to the built form.
- 4 BALCONY PLANTING**
Balcony planting can assume a vast variety of forms, including everything from minor planting built into the balustrade, to medium sized trees, embedded into the balcony.
- 5 GROUND PLANE GARDENS**
Ground plane gardens contribute green amenity and habitable spaces to the street edge.
- 6 INTERNAL GARDENS**
Skylights create the opportunity to embed significant trees and internal courtyards into buildings, creating opportunities for green relief.

7.4 FLEXIBLE, ROBUST AND FUTURE PROOFED

Design flexible, adaptable, future proofed residential buildings that can endure evolving environmental, technological and social challenges.

Designing flexible, adaptable, future-proofed and robust residential buildings allows them to meet the changing needs of occupants over time, while also remaining resilient in the face of evolving environmental and technological challenges. By incorporating adaptable features and materials, buildings can be future-proofed and remain functional and liveable for generations to come. This approach improves the sustainability of residential buildings, providing long-term benefits to both occupants and the environment.

DESIGN GUIDANCE

7.4A ROBUST, LOW MAINTENANCE MATERIALS

- i. Incorporate sustainable materials for floors that are durable, low maintenance, resistant to warping/shrinking and flexible, to minimise maintenance.
- ii. When selecting exterior cladding/masonry materials, consider the maintenance and climate to ensure they can withstand natural elements and age well in terms of aesthetics.
- iii. Ensure roofs are made of durable and low-maintenance materials that can last.
- iv. Consider moisture resistance, pest damage, fire damage and fading over time in choice of exterior cladding material.
- v. When specifying window framing, ensure materials are low maintenance, durable, energy-efficient, resistant to corrosion and available in a broad range of colours.
- vi. Ensure choice of materials and finishes throughout aligns with total maintenance life of interrelated components to avoid unnecessary or repetitive replacement of materials.
- vii. During material specification, consider entire material life cycle and circular economy processes to reduce embodied carbon emissions.
- viii. Re-use and recycle materials where possible and appropriate.

Why this is important:

Our world is changing in many ways and will continue to do so. Many new buildings will outlast their current specific use and should be designed for flexibility to minimise future waste and expense.

7.4B FLEXIBLE, ADAPTABLE AND FUTURE PROOFING

- i. Design structural systems to allow for adaptation of apartments over time.
- ii. Design apartments with rooms of high amenity and natural light that can facilitate multiple, changing uses over time through future refurbishments.
- iii. Incorporate flexible, multi-use spaces that can be adapted for different purposes, such as workspaces and exercise areas, and increase the versatility of the building.
- iv. Implement Universal Design strategies, such as wider doorways and hallways, smooth threshold transitions and provision for structural transition to elements such as grab rails in bathrooms to make apartments more responsive to different accessibility requirements.
- v. Minimise the use of load-bearing partition walls to improve the flexibility of the internal layout and facilitate easier and more cost-effective refurbishment and reconfiguration.
- vi. Where appropriate, design ground floors to be flexible and easily allow a wide array of reconfigurations through use of high ceilings, spacious column separation, flexible utilities and modular ceiling grids.
- vii. Locate services in areas where they will not impede strategies for adaptive reuse/alteration.
- viii. Where appropriate, use dedicated service risers to provide space for future installation or modification of building systems without disrupting existing apartments.
- ix. Where appropriate, design podium level car parking with appropriate ceiling heights that enable retrofitting for other uses such as residential or commercial conversion.

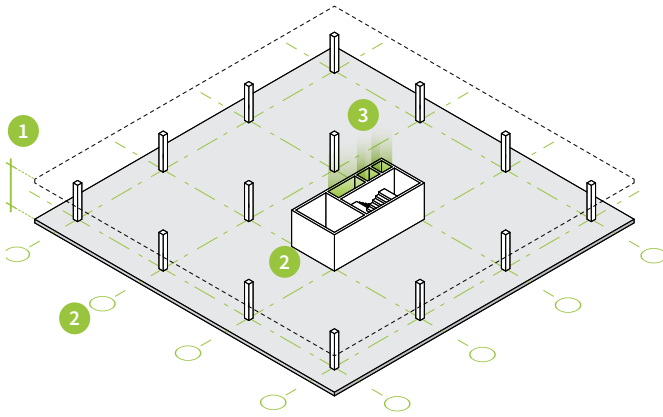

1 FLOOR-TO-FLOOR HEIGHT

Car parks can be designed with a higher than typical floor to floor height so they can be adapted for residential or other uses.

2 STRUCTURAL GRID AND CORE

Keeping columns to a regular grid and locating the core rationally allows maximum flexibility for reconfiguration in the future.

3 SERVICES

Service risers should be easily accessible and appropriately sized to accommodate upgrades later in the building's life.

Figure 28: Flexible and future proofed building design

Exemplar of adaptive re-use:

The Alexander and Albemarle project is a great case study of adaptive reuse of derelict Australian Government office accommodation built in the 1960s into a rejuvenated mixed-use precinct that includes retail, commercial, childcare, residential, hospitality, and health and wellbeing.

Due to their original commercial purpose, the apartments are afforded higher than usual ceilings, and robust footprints.

Photo 27:
Alexander and Albemarle
Redevelopment, Philip, ACT.
Architect: Cox Architecture



7.5 SOCIAL RESILIENCE

Design socially resilient buildings that provide residents with safety, security and connection to community.

Designing residential buildings with social resilience in mind creates a safe and stable environment for residents. Socially-resilient buildings promote social cohesion, encourage community involvement, and provide access to essential resources and services. Socially resilient buildings also promote long-term sustainability and provide residents with a sense of safety, security and connectedness, fostering a thriving and healthy community.

DESIGN GUIDANCE

7.5A AFFORDABILITY AND ECONOMIC DIVERSITY

- i. Where possible, incorporate a diverse mix of apartment types and affordability to diversify the internal building population so communities are not homogenised based on wealth.
- ii. Explore the potential to use a mixture of housing models in new developments in line with the ACT Housing Strategy to encourage diverse communities and create flexibility for future models of occupation.
- iii. Provide generous communal spaces that create opportunities for residents and visitors to interact and connect with each other. As household groups shrink and change, well designed communal spaces are an effective way to minimise loneliness without compromising privacy or personal amenity.

7.5B SENSE OF COMMUNITY AND SOCIAL COHESION

- i. Incorporate shared spaces, such as courtyards, gardens, rooftop spaces or community rooms where residents can socialise, host events or gather for activities and meetings.
- ii. Embed organisation and processes that encourage residents to host events and activities to bring residents together and facilitate social connections.
- iii. Embed infrastructure such as outdoor power and lighting to enable communal events to encourage residents to have shared experiences and socialise.
- iv. Incorporate visual clues and invitations to interact through graphic treatment, artworks and furniture such as loose and moveable seating and tables and unique furniture near circulation areas.
- v. Establish communication channels and processes that allow residents to stay informed about building news and events.
- vi. Incorporate design elements that foster a welcoming atmosphere in communal areas, such as comfortable seating, high quality artwork and generous planting areas.
- vii. Where appropriate, provide spaces for physical activity such as a fitness centre or yoga studio to encourage residents to stay active, while promoting social connections.

7.5C SAFETY AND SECURITY

- i. Embed access control systems, such as key cards or passcodes to restrict access to the building so only authorised individuals can enter.
- ii. Incorporate appropriate security lighting in common areas, stairwells, and parking lots to reduce the risk of accidents and deter criminal activity.
- iii. Incorporate surveillance cameras in common areas, entryways and parking lots to monitor activities and identify potential security threats, while preventing criminal activity.
- iv. Use durable and robust materials, such as reinforced glass, steel doors and high-quality locks, to secure entryways and windows against forced entry.
- v. Ensure stairways are well lit, clear of obstructions and have non-slip surfaces. Elevators should have emergency buttons and clear signage.
- vi. Develop clear evacuation plans and post them in prominent locations throughout the building, along with designated assembly areas outside.
- vii. Avoid stark white lighting that creates dark shadows in and around the building. Incorporate warm white or coloured light to increase feelings of safety and visibility.

Related planning strategies and tools:

- i. ACT Government Wellbeing framework 2020
- ii. ACT Housing Strategy
- iii. Refer to Urban Design Guide Theme 6 for safety and inclusion.



Exemplar:

A community garden as a joint initiative of the Suburban Land Agency (ACT Government) and the Woodlands and Wetlands Trust. The garden aims to provide an opportunity for people to connect and learn about gardening, the local environment and each other.

Photo 28: Dairy Road Community Garden, ACT.

7.6 GOVERNANCE MODELS AND PROCESSES

Implement processes that standardise best practice and embed sustainable design practices and technologies in all projects.

Sustainable processes for construction, operation and maintenance provide a framework for designers and builders to prioritise sustainability in their decision-making. These mechanisms ensure that sustainable building practices are standardised and enforced, driving the adoption of more sustainable designs and technologies. Moreover, sustainable governance processes encourage collaboration between stakeholders, resulting in more holistic and integrated approaches to sustainable building design that consider social, economic and environmental factors.

DESIGN GUIDANCE

7.6A PROCUREMENT, CONSTRUCTION, UPCYCLING AND EMBODIED CARBON

- i. During design stages, take into account assembly and disassembly in construction and deconstruction after use to minimise embodied carbon emissions.
- ii. Minimise embodied emissions of the construction for example, through re-used, recycled, low-carbon materials, locally sourced and low-emission materials to reduce the emissions associated with the extraction of raw materials, the manufacturing and refinement of materials, transportation, installation and disposal of old supplies.
- iii. Quantify and report on the embodied emissions attributable to the development.
- iv. Incorporate circular processes in demolition and disassembly activities to close material loops and reduce waste and emissions through selective removal of structural components like window

Tip: The Australian Institute of Architects goals, which are aligned to GBCA (Green Building Council of Australia) goals:

- Nationally consistent methodology for mandatory embodied emissions measurement and reporting in state and territory legislation by 2025.
- All new buildings and major renovations having net zero operational carbon emissions by 2030.
- All new buildings have a 40% reduction in embodied carbon by 2030.
- All existing buildings having net zero operational carbon emissions by 2040.
- All new buildings and major renovations have net zero embodied carbon by 2040.

frames, doors, materials and components of existing buildings.

- v. Consider the adaptive reuse and refurbishment of existing buildings where possible, to prevent demolition and the loss of resources in the economy.

7.6B WASTE MANAGEMENT

- i. Equip every dwelling with convenient access to a waste segregation system that separates waste streams to better enable recycling, organic composting, or processing of different materials. Organics should be able to be conveniently disposed of separately to general waste and recycling.
- ii. Embed either shared or individual facilities that enable composting to reduce the amount of waste sent to landfills and provide nutrient-rich soil for community gardens.
- iii. Provide efficient waste disposal systems that reduce the need for manual handling and transport of waste to reduce the associated costs and carbon footprint.
- iv. Embed sufficient space within communal collection areas for bulky items to prevent dangerous disposal of items in public areas and provide opportunity for reuse by others.
- v. Equip each dwelling with sufficient provision for a minimum of 2 days waste storage, plus storage for recyclables and organics.

Related planning strategies and tools:

- i. ACT Urban Design Guide Theme 5 - Governance models and processes
- ii. ACT Circular Economy Strategy 2022-2025 Draft
- iii. ACT Climate Change Strategy 2019-2025
- iv. ACT Waste Management Strategy 2011-2025
- v. Green Building Council - Upfront Carbon Emission calculation guide

Exemplar:

World's first upcycled skyscraper retains more than 65% of the original structure (beams, columns and slabs) and 95% of the original core, resulting in an embodied carbon saving of 12,000 tonnes (the equivalent of 35,000 flights between Sydney and Melbourne).

Photo 29:

Quay Quarter Tower, Sydney NSW. Architects: 3XN, Photograph: Courtesy of 3XN © Adam Mork

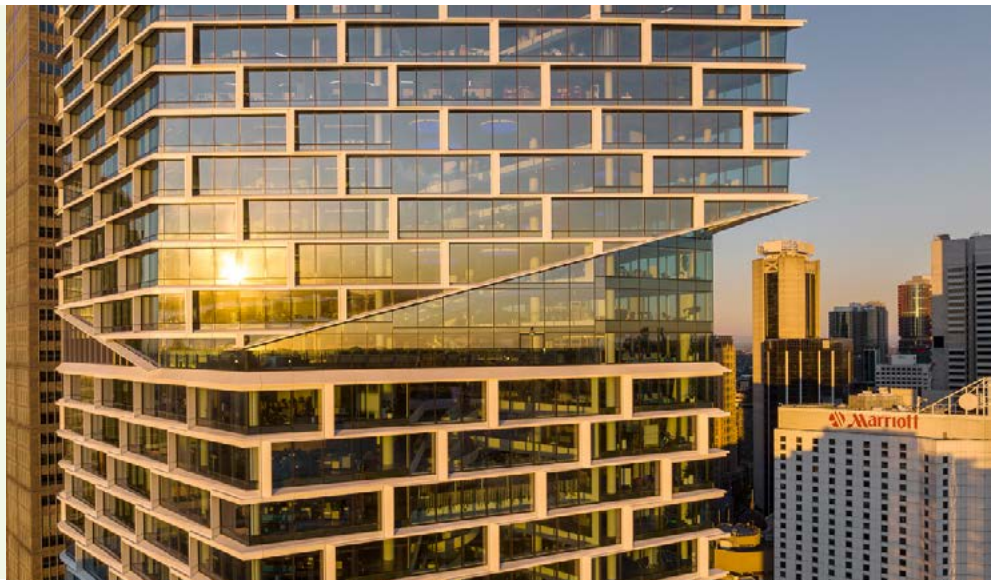
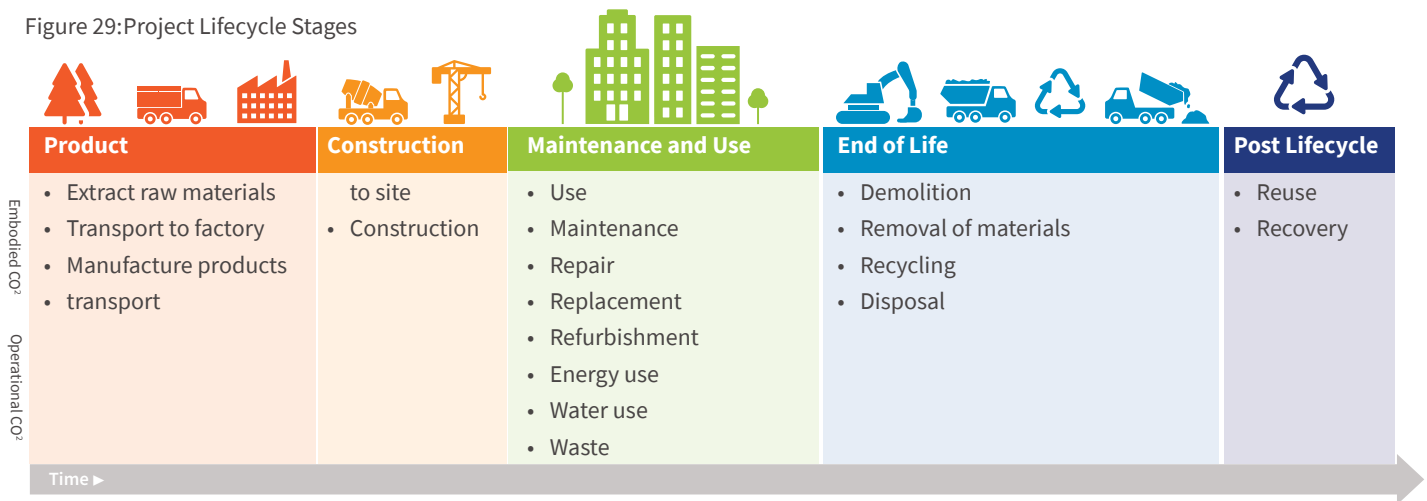

Figure 29: Project Lifecycle Stages



Tip:

Provide storage within each dwelling for a minimum 2 days of recyclables, organic and general waste with source separation. Provide access to communal collection points for these at each level of multi-storey development (via chutes or dedicated containers).

Why this is important:

Considering the carbon footprint of development over its entire lifecycle is critical to managing climate change and minimising negative environmental impacts. Material selection, waste management strategy and passive design can significantly reduce greenhouse gas emissions and running cost for housing. It can also significantly increase resident wellbeing.





Part Three: Appendices

Hasset Park in Campbell, ACT.
Design: Hill Thalys Architecture

HOUSING DESIGN CHECKLIST

This design criteria checklist is an evaluation tool for those involved in the planning, design and delivery of built environment projects to demonstrate that a given project achieves good design outcomes in the ACT context. It could be used at several stages throughout a project, from early design concepts, to detailed proposals and completed works.

COUNTRY AND PLACE	NOTES
1.1 NGUNNAWAL CULTURAL RESONANCE	
1.1A Governance, process, and engagement	<input type="checkbox"/>
1.1B Buildings, spaces and landscape character	<input type="checkbox"/>
1.1C Wayfinding and navigation	<input type="checkbox"/>

URBAN STRUCTURE AND NATURAL SYSTEMS	NOTES
-------------------------------------	-------

This theme supports the interpretation, application and assessment of the following assessment outcomes as outlined in the Territory Plan:

- Biodiversity connectivity is maintained across the landscape.
- Loss of native habitat and biodiversity is avoided and/or minimised.
- The health and functionality of waterways and catchments is maintained, including through application of water sensitive urban design principles.

2.1 OPEN SPACE NETWORK

Open space network

UDG:

- **2.1B** Type, size, quality, function and connectivity
- **2.1C** Topography and views

2.2 NATURAL SYSTEMS

Natural systems

UDG:

- **2.1A** Natural systems
- **2.2A** Connectivity and access
- **2.2B** Water management
- **2.2C** Restoring ecology
- **5.3C** Positive engagement with nature
- **5.3D** Biodiversity habitats
- **7.1A** Water sensitive urban design

SITE AND LAND USE

NOTES

This theme supports the interpretation, application and assessment of the following assessment outcomes as outlined in the Territory Plan.

- The functionality and usability of the development is appropriate for its intended purpose/use.
- The proposed use and scale of development are appropriate to the site and zone.
- Adverse impacts of development on surrounding uses (both within a site and on adjoining sites) is minimised and residential amenity protected. This includes between residential uses and between non-residential and residential uses

3.1 SITING

3.1A Solar orientation	<input type="checkbox"/>
3.1B Prevailing winds and cross ventilation	<input type="checkbox"/>
3.1C Setbacks and separation	<input type="checkbox"/>
3.1D Privacy and outlook	<input type="checkbox"/>

3.2 BUILT FORM

3.2A Building floorplates, depth and articulation	<input type="checkbox"/>
3.2B Building heights	<input type="checkbox"/>

3.3 STREET INTERFACE

3.3A Building to street interface	<input type="checkbox"/>
3.3B Building entries	<input type="checkbox"/>
3.3C Vehicles and servicing	<input type="checkbox"/>
3.3D Façade, massing and articulation	<input type="checkbox"/>
3.3E Lower storeys above ground floor (up to four storeys)	<input type="checkbox"/>
3.3F Setback to street	<input type="checkbox"/>
3.3G Ground level	
3.3H Materiality	<input type="checkbox"/>

3.4 PRIVATELY OWNED PUBLIC SPACES (POPS)

3.4A POPS general	<input type="checkbox"/>
3.4B Parks and plaza	<input type="checkbox"/>
3.4C Forecourts	<input type="checkbox"/>
3.4D Landscaped setbacks	<input type="checkbox"/>
3.4E Cross-block connections	<input type="checkbox"/>
3.4F Laneways	<input type="checkbox"/>
3.4G Arcades/interior connections	<input type="checkbox"/>
3.4H Courtyards	<input type="checkbox"/>

ACCESS AND MOVEMENT

NOTES

This theme supports the interpretation, application and assessment of the following assessment outcomes as outlined in the Territory Plan.

- The functionality and layout of the development is accessible and adaptable, while achieving good connections with the surrounding area. This includes consideration of traffic flow and passive surveillance.
- The development encourages active travel through safe and convenient access to the active travel network.
- Access to, from and within the site permits safe and legible movement while catering for all users (including pedestrians). This includes consideration of vehicle manoeuvrability and access routes.
- The development provides electric vehicle parking and access to charging locations in multi-unit housing.
- The development provides appropriate end-of-trip facilities in multi-unit housing which includes secure bicycle parking.

4.1 SITE ACCESS AND CONNECTIVITY

On site access

UDG:

- **6.1A** Block permeability
- **4.6B** Parking access and entries
- **4.6H** Access to buildings and parking
- **4.6I** On site access
- **4.6J** Green accessways on lots

Cross block links

UDG:

- **6.1A** Block permeability

HDG:

- **3.4E** Cross-block connections
- **3.4F** Laneways
- **3.4G** Arcades / interior connections

4.2 PARKING AND SERVICES

Vehicle access and driveways

UDG:

- **4.6B** Parking access and entries

Parking

UDG:

- **4.6D** Underground parking
- **6.2D** Sleeved podium parking and services

Electrification and ZE vehicles

UDG:

- **4.6G** Electrification and zero emission vehicles

Integrated services

UDG:

- **6.2C** Ground floor services and infrastructure

4.3 ENGAGING WITH THE STREET

ACCESS AND MOVEMENT**NOTES****Street and building interface**

UDG:

- **6.3** Ground floor edge conditions

HDG:

- **3.3A** Building to street interface
- **3.3F** Setback to streets

Building entries

UDG:

- **4.6H** Access to buildings and parking
- **4.6I** On site access

HDG:

- **3.3B** Building entries

Landscaping and canopy cover

HDG:

- **3.4D** Landscaped setbacks

UDG:

- **4.6J** Green accessways on lots
- **5.3A** Boosting tree canopy and coverage
- **5.3B** Local planting and vegetation species

4.4 ACTIVE TRAVEL**Safe pedestrian/cycle access**

UDG:

- **4.4A** Safe, inclusive and legible active travel network

End of trip facilities

UDG:

- **4.4C** Supporting infrastructure for active travel
- **4.6I** On-site access

PUBLIC SPACE AND AMENITY

NOTES

This theme supports the interpretation, application and assessment of the following assessment outcomes as outlined in the Territory Plan:

- The development (including the design of outdoor spaces) achieves reasonable solar access and microclimate conditions to public areas and streets to support their use by the community.
- Private open space and communal open space provides sufficient space and facilities for residents and visitors to recreate and relax, as well as providing area for service functions. Spaces are readily accessible for a range of activities.
- Reasonable levels of active ground floor interface and passive surveillance to public spaces and streets is achieved.
- Any advertising or signs are suitable for their context and do not have a detrimental impact on the surrounding area (for instance due to size or light emission).

5.1 COMMUNAL OPEN SPACE

Cross block links

UDG:	
– 4.6I On-site access	<input type="checkbox"/>
– 4.6J Green accessways on lots	<input type="checkbox"/>
– 6.1A Block permeability	<input type="checkbox"/>
HDG:	
– 3.4E Cross-block connections	<input type="checkbox"/>
– 3.4F Laneways	<input type="checkbox"/>
– 3.4G Arcades/interior connections	<input type="checkbox"/>

Privately owned public spaces

HDG:	
– 3.4A POPS general	<input type="checkbox"/>
– 3.4B Parks and plazas	<input type="checkbox"/>
– 3.4C Forecourts	<input type="checkbox"/>
– 3.4D Landscape setbacks	<input type="checkbox"/>
– 3.4H Courtyards	<input type="checkbox"/>
– 6.1B Size and location	<input type="checkbox"/>
– 6.1C Integrated landscaping	<input type="checkbox"/>

5.2 PRIVATE OPEN SPACE

Amenity

UDG:	
– 6.1C Orientation	<input type="checkbox"/>
– 6.1D Overshadowing	<input type="checkbox"/>
HDG:	
– 3.1A Solar orientation	<input type="checkbox"/>
– 3.1D Privacy and outlook	<input type="checkbox"/>
– 6.4A Private open space and balconies	<input type="checkbox"/>
– 6.4B Connections	<input type="checkbox"/>

5.3 QUALITY PUBLIC SPACE

PUBLIC SPACE AND AMENITY

NOTES

Green infrastructure

UDG:

- **5.4A** Street planting and canopy
- **5.3A** Boosting tree canopy and coverage
- **5.3B** Local planting and vegetation species

HDG:

- **3.4D** Landscaped setbacks
- **7.3A** Deep soil planting and tree canopy cover
- **7.3B** Integrated green infrastructure

Furniture and materials

- **5.6A** Urban furniture
- **5.6B** Public spaces and places material treatment

5.4 DIVERSE USERS AND AMENITIES

Inclusivity

UDG:

- **5.5A** Crime Prevention Through Environmental Design (CPTED)
- **5.5B** Inclusive design elements
- **5.5C** Gender sensitive urban design principles
- **5.5E** Lighting

Amenities

UDG:

- **5.2A** Flexibility, adaptability and activation capacity
- **5.2B** Responsive design and programming
- **5.2C** Pedestrian comfort, urban amenities and conveniences
- **5.5D** Legibility and wayfinding

This theme supports the interpretation, application and assessment of the following assessment outcomes as outlined in the Territory Plan.

- The height, bulk and scale of the development is appropriate, noting the desired zone policy outcomes and the streetscape. This includes consideration of building envelope and setbacks.
- Reasonable solar access to dwellings and private open space within a block and on adjoining residential blocks is achieved. This includes solar access into main living spaces within a dwelling.
- Reasonable levels of privacy to dwellings and private open space within a block and on adjoining residential blocks is achieved.
- The dwelling mix and the internal size, scale and layout of dwellings in multi-unit housing provide for a comfortable living environment that meets the changing needs of residents. This includes consideration of cross-ventilation and energy efficiency.
- Courtyard walls and fences do not have an adverse impact on the streetscape.
- Vehicle and bicycle parking sufficiently caters for the development while minimising visual impacts from the street or public space. This includes consideration of parking location, dimensions and number of spaces provided.

6.1 COMMUNAL OPEN SPACE

6.1A Activities and uses	<input type="checkbox"/>
--------------------------	--------------------------

6.1B Size and location	<input type="checkbox"/>
------------------------	--------------------------

6.1C Integrated landscaping	<input type="checkbox"/>
-----------------------------	--------------------------

6.2 COMMON CIRCULATION

6.2A Common circulation and spaces	<input type="checkbox"/>
------------------------------------	--------------------------

6.3 DIVERSE HOUSING CHOICES

6.3A Types of housing	<input type="checkbox"/>
-----------------------	--------------------------

6.3B Apartment size and layout	<input type="checkbox"/>
--------------------------------	--------------------------

6.3C Ceiling heights	<input type="checkbox"/>
----------------------	--------------------------

6.3D Complementary uses	<input type="checkbox"/>
-------------------------	--------------------------

6.3E Housing accessibility	<input type="checkbox"/>
----------------------------	--------------------------

6.4 PRIVATE OPEN SPACE

6.4A Private open space and balconies	<input type="checkbox"/>
---------------------------------------	--------------------------

6.4B Connections	<input type="checkbox"/>
------------------	--------------------------

6.5 STORAGE

6.5A Within dwellings	<input type="checkbox"/>
-----------------------	--------------------------

6.5B Bulky items	<input type="checkbox"/>
------------------	--------------------------

6.6 DESIGN PERFORMANCE

6.6A Solar and daylight access	<input type="checkbox"/>
--------------------------------	--------------------------

6.6B Shading	<input type="checkbox"/>
--------------	--------------------------

6.6C Thermal performance	<input type="checkbox"/>
--------------------------	--------------------------

6.6D Natural ventilation	<input type="checkbox"/>
--------------------------	--------------------------

6.6E Noise and acoustic comfort	<input type="checkbox"/>
---------------------------------	--------------------------

6.6F Visual amenity	<input type="checkbox"/>
---------------------	--------------------------

SUSTAINABILITY AND ENVIRONMENT

NOTES

This theme supports the interpretation, application and assessment of the following assessment outcomes as outlined in the Territory Plan:

- Sufficient planting area, canopy trees, deep soil zones and water sensitive urban design measures are provided to enhance living infrastructure, support healthy tree growth and minimise stormwater runoff.
- Urban heat island effects are reduced through limiting impervious surfaces and provision of canopy trees and plants.
- Threats to biodiversity such as noise, light pollution, invasive species incursion or establishment, chemical pollution, or site disturbance are avoided or minimised through good design.
- Minimise cut and fill to protect natural hydrological function and limit soil erosion and site disturbance.
- The development considers and addresses site characteristics, including heritage, natural features, topography, infrastructure and utilities.
- Environmental risks, including noise, bushfire, flooding, contamination, air quality or hazardous materials are appropriately considered for the development on the site.
- Waste is appropriately managed on site without having a detrimental impact on residents and the surrounding area.
- The site is appropriately serviced in terms of infrastructure and utility services and any associated amenity impacts are minimised.

7.1 CLIMATE CHANGE RESILIENCE

7.1A Flood resilience

7.1B Bushfire resilience

7.1C Heatwave and urban heat island resilience

7.2 RESOURCE CAPTURE AND MANAGEMENT

7.2A Rainwater capture and reuse

7.2B Energy capture and management

7.2C Electrification and energy efficiency

7.2D Local food production

7.3 INTEGRATED LANDSCAPE PLANTING

7.3A Deep soil planting and tree canopy cover

7.3B Integrated green infrastructure

7.4 FLEXIBLE, ROBUST AND FUTURE-PROOFED

7.4A Robust, low maintenance materials

7.4B Flexibility, adaptability and future proofing

7.5 SOCIAL RESILIENCE

7.5A Affordability and economic diversity

7.5B Sense of community and cohesion

7.5C Safety and security

7.6 GOVERNANCE MODELS AND PROCESSES

7.6A Procurement, construction, upcycling and embodied carbon

7.6B Waste management

DOCUMENT REFERENCES

A literature review was undertaken and the relevant policies and documents listed below are referenced throughout this design guide. In addition, earlier review work engaged by the Planning Review and Reform Project provided a clear baseline for what constitutes good design.

POLICY

Planning technical specifications

New Territory Plan

Planning Bill 2022

GOVERNMENT PLANS

National Capital Plan

The Griffin Legacy

A blueprint for the future development of the central national areas, ACT Government 2006

ACT Infrastructure plan

ACT Canberra's Living Infrastructure Plan: Cooling the City

ACT Powering Canberra our Pathway to Electrification

ACT Conservation Effectiveness Monitoring Plan

ACT STRATEGIES

District strategies

2022 draft planning strategies for each of the ACT districts: East Canberra, Belconnen, Gungahlin, Inner North and City, Inner South, Molonglo Valley, Tuggeranong, Weston Creek, and Woden

ACT Planning Strategy 2018

ACT Transport Strategy 2020

ACT Climate Change Strategy 2019-2025

ACT Digital Strategy 2020

ACT Water Strategy

ACT Circular Economy Strategy

ACT Urban Forest Strategy

ACT Waste Management Strategy 2011 - 2025

ACT City Plan

ACT and Region Catchment Strategy

ACT Nature Conservation Strategy 2012-2023

ACT Key Threatening Processes (KTP)

ACT Native Woodland Conservation Strategy and Action Plans

ACT Native Grassland Conservation Strategy and Action Plans

Zero Emissions Vehicles Strategy 2022-2023

CRA Sustainability Strategy 2019-2025

CRA Urban Art Strategy

Aquarian and Riparian Conservation Strategy and Action Plans

STUDIES

ACT Planning Reform - Delivering Best-Practice Urban Design Through Planning, 2021. Hodyl & Co, Andy Fergus, Adams Urban, Oculus and Creative Environment Entrprises

Environment Protection Guidelines for Construction and Land Development in the ACT Municipal Infrastructure Design Standards

Hodyl and Co Planning System Review and Reform - Achieving Improved Built Form, Place Design & Public Realm Design Outcomes

GUIDES

Gawari Ngilanmanyin. Remembering the Bush. A Climate-wise Landscape Guide for the ACT

ACT Microclimate Assessment Guide (Forthcoming)

ACT Practice Guidelines for Ecologically Sensitive Urban Design (to be developed)

ACT Separation Distance Guidelines for Air Emissions

Practice Guidelines for Water Sensitive Urban Design in the ACT and Water Sensitive Urban Design General Code National Capital Design Review Panel

ACT National Capital Design Review Panel: Design Principles for the ACT

Practitioner's guide, Preparing for design review

A practical guide to electrification for new buildings

Green Building Council Australia

Bringing embodied carbon upfront

World Green Building Council

FRAMEWORKS

ACT Wellbeing Framework

ACT Economic Development Priorities 2022-2025: CBR Switched on

ACT Gender Sensitive Urban Design Framework

City Gateway Urban Design Framework

City Centre Urban Design Framework

ACT Gender Sensitive Urban Design Framework

ACT Living Infrastructure Plan

The Griffin Legacy

GLOSSARY

This glossary identifies the words and acronyms that appear frequently throughout the Housing Design Guide, to help the reader identify unfamiliar words and industry specific terminology.

The terms in the glossary do not replace defined terms or uses in the Territory Plan, refer to Territory plan definitions for any development applications.

ACT – Australian Capital Territory

Accessibility – The ease of reaching destinations. In a highly accessible location, a person, regardless of age, ability or income, can reach many activities or destinations quickly, whereas people in places with low accessibility can reach fewer places in the same amount of time.

Activations – A place with the appropriate facilities that invite people to spend time in that space, thereby activating it, making it lively.

Active frontages – Occurs where there is active visual or tactile engagement between the ground and upper floor of buildings and the adjacent street/public space.

Active travel – Any form of transport involving physical activity, e.g., cycling and walking.

Active use – Active uses are uses that generate many visits, in particular pedestrian visits, over an extended period of the day.

Adaptive reuse – Projects that give new life to an existing place, building or structure through sympathetic alterations, conversions and additions that enable compatible new uses and functions, while maintaining the heritage significance where applicable.

Affordable housing – Housing that is appropriate for the needs of a range of very low to moderate income households, and priced (whether mortgage repayments or rent) so these households are able to meet their other essential basic living costs. It differs to social housing which is provided and/or managed by the government (public housing) or by a not-for-profit organisation (community housing). Housing is often defined as affordable when a household spends less than 30% of their income on housing costs, and that household falls within the lowest 40% of household incomes.

Amenity – The features of an area, street or building, that provide facilities and services that contribute to physical or material comfort and benefit and are valued by users. Amenity is important in the public, communal and private domains.

Articulation – An area in front of the building line that may contain porticos, balconies, bay windows, decks, patios, pergolas, terraces, verandas, window box treatments, window bays, awnings and sun-shading features.

Attached housing – means any dwelling, within a building containing two or more dwellings, which has within its curtilage open space at ground level and separate private access for each dwelling for the exclusive use of the occupants of the dwelling. Attached housing may incorporate communal basement car parking. Attached housing includes row house, semi-detached house, terrace house, townhouse.

Building depth – The overall cross-section dimension of a building envelope. It includes the internal floorplate, external walls, balconies, external circulation and articulation such as recesses and steps in plan and section.

Building edges – The façade plane of a building's ground floor faces the outer perimeter of a site.

City Centre – The area broadly defined by Canberra's civic centre and bordered by the outer hexagonal road (Cooyong Street and extensions) radiating from City Hill, ANU and Lake Burley Griffin (map included in Commercial Zones Policy).

City Plan/CP – ACT Government document establishing the long-term vision for Canberra City Centre.

Communal open space – Communal open space means common outdoor open space within an easily accessible location on the subject site for recreation and relaxation of residents of a housing development.

Connectivity – The number of connecting routes and intersections within a particular area. An area with high connectivity provides multiple routes to and from destinations.

Corner apartment – Cross ventilating apartments on one level with aspects at least 90 degrees apart. Corner apartments are commonly located on the outermost corners of buildings.

Courtyard – Communal space at ground level or on a structure (podium or roof) that is open to the sky, formed by the building and enclosed on 3 or more sides.

CRA – City Renewal Authority.

Cross-over apartment – A cross ventilating apartment with two opposite aspects and with a change in level between one side of the building and the other.

Cross-through apartment – A cross ventilating apartment on one level with two opposite aspects

CPTED – Crime Prevention Through Environmental Design.

Datum – A significant point or line in space established by the existing or desired context, often defined as an Australian Height Datum. For example, the top of significant trees or the cornice of a heritage building.

Daylight – light generated from the sun (Often measured in Lux).

Deep soil zone – An area of soil within a development that is unimpeded by buildings or structures below ground, and which has adequate dimensions to allow for the growth of healthy trees. Deep soil zones exclude basements, services, swimming pools, tennis courts and impervious surfaces including car parks, driveways, podium, and roof areas.

Density – Average number of residents, households, dwellings, or habitable space in a given area, usually expressed as dwellings/ people per hectare or floor area ratio.

Dense urban environment – an area characterised by a relatively a high concentration of dwellings, buildings and people.

Desired Character - means the form of development in terms of siting, building bulk and scale, and the nature of the resulting streetscape that is consistent with the relevant desired outcomes, and any statement of desired character in a relevant district code. It does not necessarily reflect the existing character of the area.

Dual aspect apartment – Apartments which have at least 2 major external walls facing in different directions, including corner, cross-over and cross-through apartments, which provide for and improve ventilation.

Dual occupancy – means the use of land that was originally used or leased for the purposes of single dwelling housing for two dwellings.

Dual key apartment – An apartment layout with a common internal corridor and lockable doors to sections within the apartment so that it is able to be separated into 2 independent units. Dual key apartments are regarded as two dwellings.

Embodied Emissions – Attributable to development, means the greenhouse gas emissions resulting from the materials used to construct a building that forms part of the development, including emissions from:

- the extraction of raw materials that are used to construct the building,
- transportation of materials,
- the manufacture of the materials used to construct the building.

Enclosure – Where building height and open space width created a feeling of contained space.

EPSDD – Environment, Planning and Sustainable Development Directorate.

Façade – The external face of a building, generally the principal face, facing a public street or space.

GLOSSARY

Continued from previous page

Floor plate – The total floor area of a storey within a building or structure.

GBCA – Green Building Council of Australia

Good design – Architectural and urban design outcomes are expected to comply with good practice design principles as a minimum ambition.

Green roof – A roof surface that supports the growth of vegetation, comprised of a waterproofing membrane, drainage layer, organic growing medium (soil) and vegetation.

Habitable – habitable (including habitable room) means a room within a dwelling capable of being lawfully used for the normal domestic activities of living, sleeping, cooking, or eating, and:

- i. includes a bedroom, study, living room, family room, kitchen, dining room, home theatre, rumpus room; but
- ii. does not include a bathroom, laundry, hallway, garage, or other spaces of a specialised nature occupied neither frequently nor for extended periods.

Habitable Spaces – Comfortable external spaces and places for people to spend time.

Heritage Place – Any place from a building to a monument, natural area, landmark or viewpoint that has special cultural or natural heritage significance. Can be identified at a local, state, federal or global level.

Infrastructure – The basic systems, facilities or framework that support a community's population, e.g., roads, transport, utilities, water, sewage.

Juliet balcony – a type of balcony that does not protrude from the building's facade, but instead, a decorative railing in front of an openable door.

Key Public Space – May be located in parks, plazas or streets. They are public places of significance, with high levels of amenity.

Legibility – The ease with which a person is able to see, understand and find their way around an area, building or development.

Living Infrastructure – The vegetation, soils and water systems that are sometimes referred to as blue or green infrastructure.

Local character/local identity– Local character makes an area distinctive and contributes to the identity of the place. This includes the natural, cultural and historic characteristics of an area that are intrinsic to the locality, and which the local community relate to. Local character and local identity are subject to change over time.

Missing middle – An umbrella term that is used to describe housing types that fall between single dwellings and apartments. Dwelling types within this category are generally low rise, medium density, and designed to meet the needs of a diverse range household types and demographics, across different life stages. Missing middle housing types may include granny flats, dual-occupancy, tri-occupancy, townhouses, terrace housing and manor houses.

Mixed-use – Mixing residential, commercial, retail, entertainment and community uses in same building, site or precinct.

Modal Interchange – Co-locating multiple public transport modes to allow for enhanced connections between alternative transport modes (e.g., bus and tram).

Natural cross ventilation – Wind-driven ventilation that provides ventilation rates at least 7 times greater than a single-aspect apartment in the same location, due to 2 or more openings on separate façade aspects being exposed to a wide range of unobstructed wind directions. The improvement in ventilation rates is to be achieved over a year.

Non-habitable room – A space of a specialised nature not occupied frequently or for extended periods,

including a bathroom, laundry, water closet, pantry, walk-in wardrobe, corridor, hallway, lobby, photographic darkroom or clothes drying room.

Operable walls – (moveable walls) are partitions or room dividers that can easily be moved and adjusted to change the layout of a space.

Passive Surveillance – Observation from the street or adjacent buildings provided by ordinary people as they go about their daily activities.

Performance glass – Typically referring to windows. Glass with high thermal performance due to double or triple glazing.

Permeability (In the context of built form) – The extent to which the urban structure allows or restricts movement of people or vehicles through an area.

Permeability (In the context of landscape) – The quantity of pervious surfaces that allow for water to penetrate into and be retained by the landscape.

Planting area – Planting area means an area of land within a block that is available for landscape planting and that is not covered by buildings, structures, vehicle parking and manoeuvring areas or any other form of impermeable element that impacts permeability of the ground surface (i.e., terraces, pergolas, patios, decks, or pools).

Plot ratio – Plot ratio means the gross floor area in a building divided by the area of the site.

Podium – The base of a building upon which taller (tower) elements are positioned.

Potable water – Water which conforms to Australian Standards for drinking quality.

Precinct – Is defined as:

- iii. development on land that forms part of a centre – group centre, town centre, local centre
- iv. development that forms part of a corridor

Primary private open space (PPOS) – means private open space that is directly accessible from a habitable room other than a bedroom.

Public space (ACT) – General term for an open area or place for public use. It is the collective, communal part of cities and towns, with shared access for all. It is the space of movement, recreation, gathering, events, contemplation and relaxation. The public space includes streets, pathways, rights of way, parks, accessible open spaces, plazas and waterways that are physically and visually accessible regardless of ownership.

Rights holder – Ngunnawal people.

Scale – The apparent size of a building in relation to its surroundings and to the scale of a person.

Solar access – The ability of a building to receive direct sunlight without obstruction from other buildings or impediments, not including trees.

Storey – Storey means a space within a building that is situated between one floor level and the floor level next above, or if there is no floor level above, the ceiling or roof above but does not include an attic or a basement or a space that contains only a lift shaft or stairway.

Street setback – means the horizontal distance between a block boundary and the outside face of any building or structure on the block.

Studio apartment – a small dwelling unit with no separate bedroom from the living area.

Sustainability – An approach that considers the environmental, social and economic aspects (such as of a building) so it can meet the needs of the present, without compromising the ability of future generations to meet their needs.

TCCS – Transport Canberra and City Services.

GLOSSARY

Continued from previous page

TGSI – Tactile ground service indicators to support people with visual impairment to navigate streets and public space.

TP / Territory Plan – Provides statutory planning guidance for development in the ACT.

Universal design – a design approach that aims to create buildings and environments that can be used by all people of all ages, abilities and backgrounds, without the need for adaptation or specialised design.

Urban design development – Urban design development is defined as:

- v. development on land that is not in an industrial zone that has a site area greater than 1 hectare; or
- vi. development in relation to which a planning instrument requires a planning and response report to be prepared for the land before development consent may be granted for the development.

In an industrial zone this only applies to a development that has a capital investment value of \$30 million or more and a site area of greater than 1 hectare.

Urban Fabric– The make-up of an urban area. Refers to characteristics such as movement network, block structure, building heights and grain.

Visual/ Temporary Activation Frontage – Engaging activation of otherwise blank frontages on buildings, fences or hoarding during construction periods.

Water Sensitive Urban Design (WSUD) – A set of design elements and on-ground solutions that aim to minimise impacts on the water cycle from our built environment and enhance our city’s liveability.

TCCS – Transport Canberra and City Services.

TGSI – Tactile ground service indicators to support people with visual disability to navigate streets and public space.

TP / Territory Plan – Providing statutory planning guidance for future development in the ACT.

Urban Fabric– The make-up of an urban area. Refers

to characteristics such as movement network, block structure, building heights and grain.

Visual/temporary Activation Frontage – Engaging activation of otherwise blank frontages on buildings, fences or hording during construction periods.

Water Sensitive Urban Design (WSUD) – A set of design elements and on-ground solutions that aim to minimise impacts on the water cycle from our built environment and enhance our city’s liveability.

Wintergardens – An enclosed balcony attached to a dwelling unit.

